



MERITORTM
A Heritage of Rockwell Technology

AXLE APPLICATION GUIDELINES

FIRE

TP-9441FT4

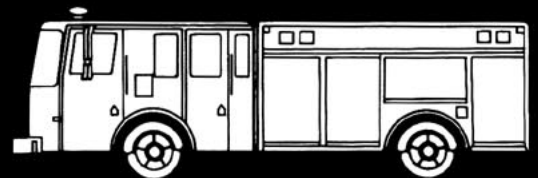
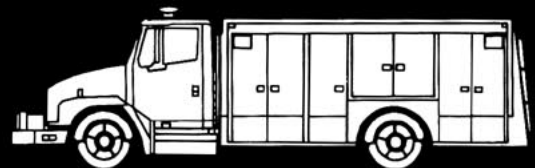
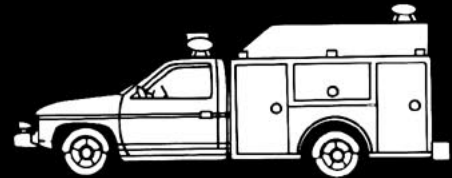
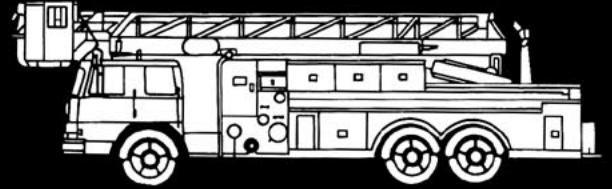
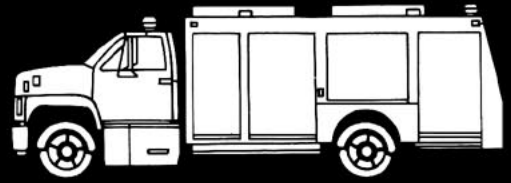

REVISED 4-98

TP-9441FT4

Fire Service Vocational Definition

Vehicles used in fighting fires. These vehicles can be used within cities as well as in rural areas. This vocation is typified by high horsepower engines and corresponding axle assemblies.

This vocation is characterized as an on-road application for 90% of the time but with vehicles having the ability to operate off-road for 10% of the time. High-speed operation with a high number of starts/stops is typical in this service.

Duty is defined as loaded full time.

Fire Service Vehicles Include:

- Ambulance
- Pumper
- Tanker Truck
- Aerial Ladder Truck
- Aerial Platform

Fire Vocation — Axle Guidelines

Intended Use of This Guideline

This document addresses approvable GAW, Axle Torque and GVW Ratings for Meritor Axles used in the Fire vocation (U.S. and Canada only).

Conditions for Approval

Axles are approved for use in the vocation covered by this document, when the axles meet the guidelines for STRUCTURE (Pages 3-17), TORQUE (Pages 18-20), and GROSS VEHICLE WEIGHT (Page 21), as described by this publication. IMPORTANT NOTES (Pages 22-24) are considered to be part of the axle approval.

For any questions concerning this document (interpretations and calculations) or for loadings, configurations or duty cycles outside the parameters of this guideline, contact Meritor Axle Engineering by telephone, by FAX or in writing to the address shown below, using the Meritor Axle Components Application form RA-4901-B-040.

MERITOR AUTOMOTIVE, INC.
AXLE ENGINEERING
2135 W. MAPLE RD. TROY, MI 48084
PHONE: 800-535-5560
FAX: 248-435-3545

Warranty

Meritor Axle Products which are included in this guideline and are operated within the vocational limitations set forth by this document are covered by Meritor's industry competitive warranty. For complete details (*and specific coverage*) refer to Meritor's Warranty Publication (SP-95155).

Consult Meritor on questions concerning warranty coverages and application approvals for products used outside of these published guidelines.

NOTE: Axle applications for tire sizes, tracks, mounting centers, other front axle KPIs, other Meritor axle models, engine/transmission torques beyond those listed, or GVW/GCW other than as shown within this **AXLE GUIDELINE** may still be approvable. Contact Meritor Axle Engineering for possible approval.

Fire Vocation — Axle Guidelines

What Is Fire Service

- Pumpers, Tankers or Aerial Ladders used in fighting structural fires.
- Operation on road surfaces made of concrete, asphalt, maintained gravel, crushed rock, hard packed dirt or other similar surfaces for 90% of the time and into sandy or muddy sites for 10% of the time.
- Low mileage operation.
- High horsepower engines typically used in this vocation.
- Three or less miles between starting and stopping (typical).
- Vehicle may use a single retarder (engine, exhaust, transmission, chassis or axle mounted).

NOTES: Increases in grades and/or number of stops/starts have a notable influence on the service life of the driving axle(s).

Vehicles using multiple retarders are not covered by this guideline.

See IMPORTANT NOTE 4 (Page 22) for Transfer Case information.

For all-wheel-drive vehicles, see IMPORTANT NOTES 12-16 (Page 23) for additional information concerning mismatch.

Types of Vehicles

- 4x2, 4x4 or 6x4 Straight trucks.

Duty Cycles

DUTY	FIRE LOADING (Refer to Page 21)	GRADES
I	100% Loaded Full Time	20% Max

Meritor Axle Models . . . nominal Fire Service Gross Axle Weight Ratings

FRONT STEER		FRONT DRIVE STEER		SINGLE REAR		TANDEM REAR		
Model	lbs	Model	lbs	Model	lbs	Model	lbs	
FC-941	8000	RF-7-120	7500	RS-13-120	13000	RT-34-145/P	34000	
FD-965	10000	RF-9-120	9000	RS-15-120	15000	RT-40-145/P/A	40000	
FF-941	12000	RF-12-120	12000	RS-17-145	17500	RT-40-160/P/A	40000	
FF-942	13500*	RF-16-145	16000	RS-19-145	19000	RT-44-145/P	44000	
FF-943	12000	RF-21-156	21000	RS-21-145/A	22000*	RT-46-160/P/A	48000*	
FF-944	13500*	RF-21-160	21000	RC-22-145/A	22000	RT-46-164/P/A	48000*	
FF-961	12000	RF-23-180	23000	RS-23-160/A	23000	RT-50-160/P/A	52000*	
FF-962	13500*			RS-23-161/A	23000	RT-52-185/180	54000*	
FF-966	12000			RS-23-186/180	24000*	RT-58-185/180	58000	
FF-967	13500*			RS-24-160/A	24000			
FG-941	14600			RS-25-160/A	27000*			
FG-943	14600			RS-26-185/180	27000*			
FL-941	21500*			RS-30-185/180	31000*			
FL-943	21500*							
				OPTION:	A = Aluminum Carrier P = Pump (Forward Carrier)			
Consult Meritor Publications TP-9727 for additional component information.								
*Special Fire Service Gross Axle Weight Ratings.								

Fire Vocation — Axle Guidelines

Front Drive & Front Non-Drive Steer & Rear Drive Axle Structural Guides

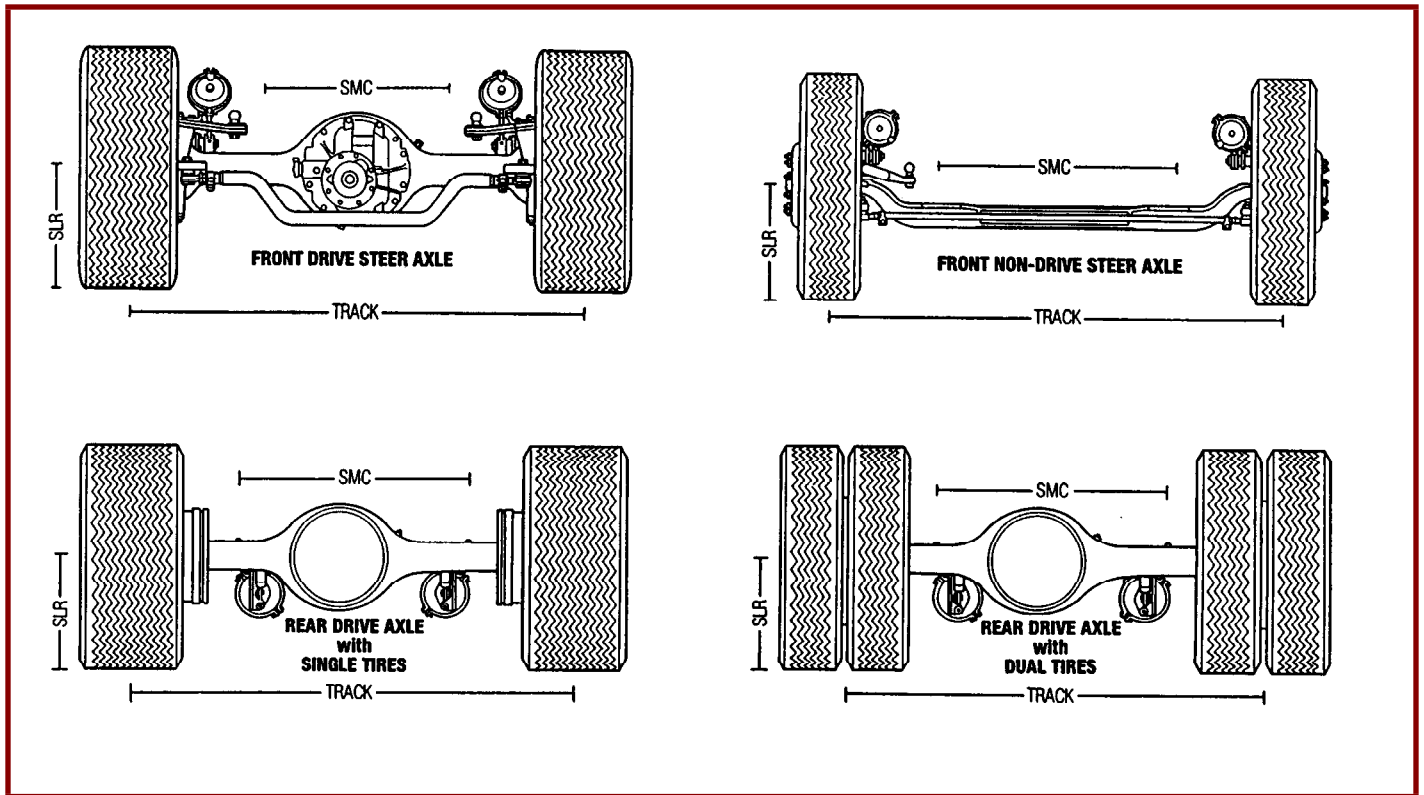

The following items determine the structural requirements of the axle:

- The load capacities (Gross Axle Weight Rating) are compared against the TRACK using the following:
 1. The maximum value of the Static Loaded Radius (SLR) of the tires.
 2. Suspension Mounting Centers (SMC).
 3. The standard front axle King Pin Intersection (KPI) dimensions.
- If single tires are used, the TRACK is measured (at the ground) from the center of one tire to the center of the opposite tire.
- If dual tires are used, the TRACK is measured from the center of the dual tires to the same point on the opposite side.
- The Gross Axle Weight Rating, as a function of SLR, and the axle SMC must meet the specifications of the graphs.

NOTE: Axle applications for tire sizes, tracks, mounting centers, other front axle KPIs and other Meritor axle models not shown within this **AXLE GUIDELINE** may still be approvable. Contact Meritor Axle Engineering for possible approval.

Fire Vocation — Axle Guidelines

Front Non-Drive Steer Axles — Structural Ratings

The approvable area is located on or below each structural curve as follows:

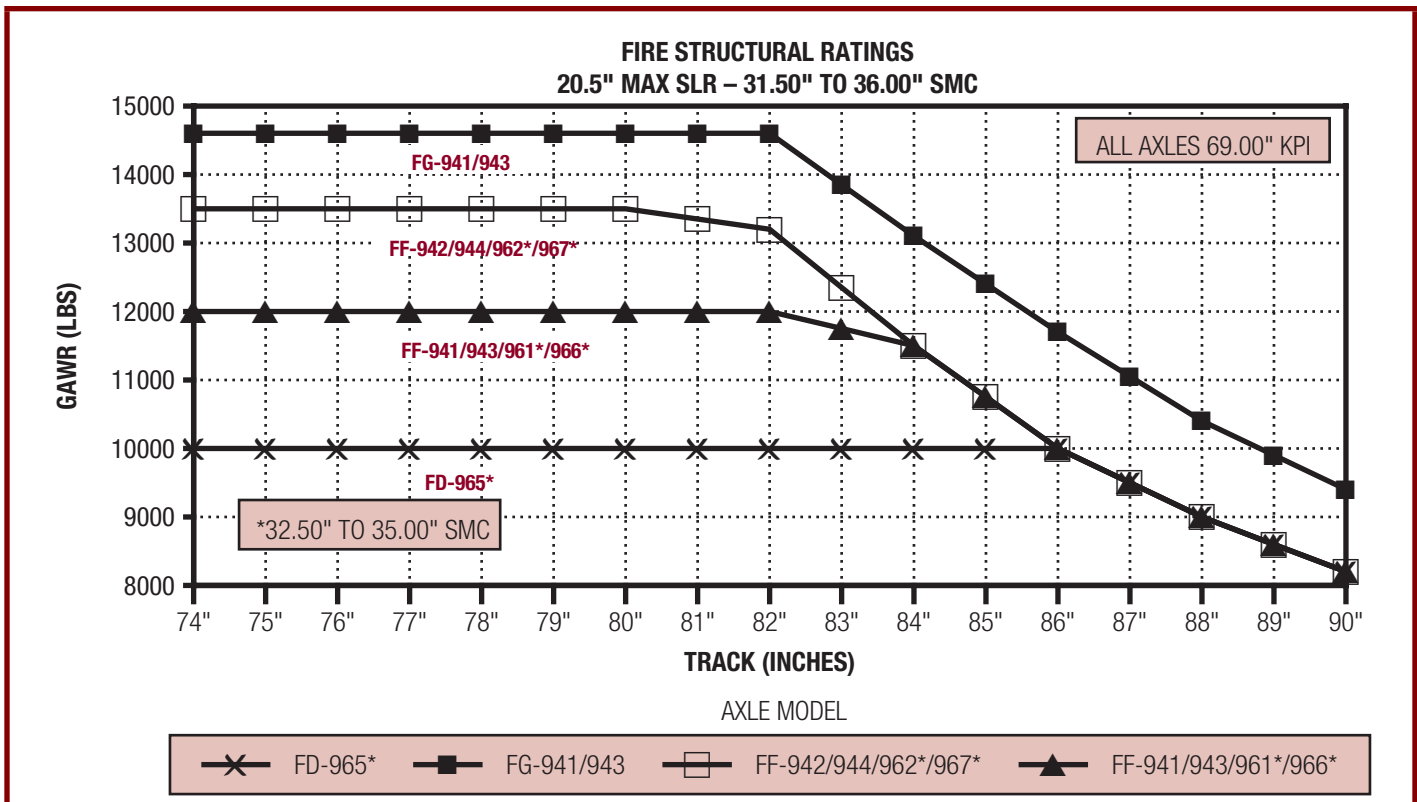
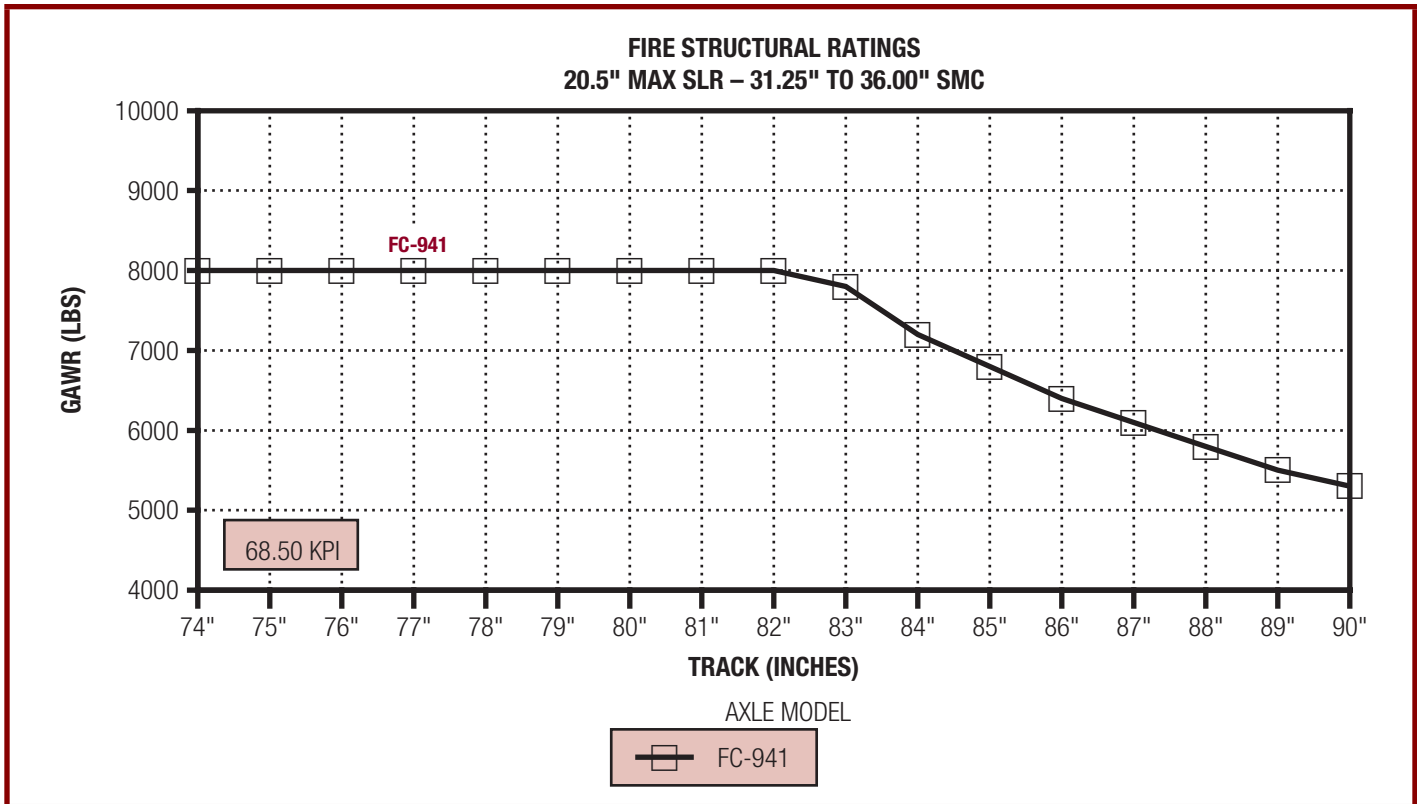

Fire Vocation — Axle Guidelines

Front Non-Drive Steer Axles — Structural Ratings

The approvable area is located on or below each structural curve as follows:

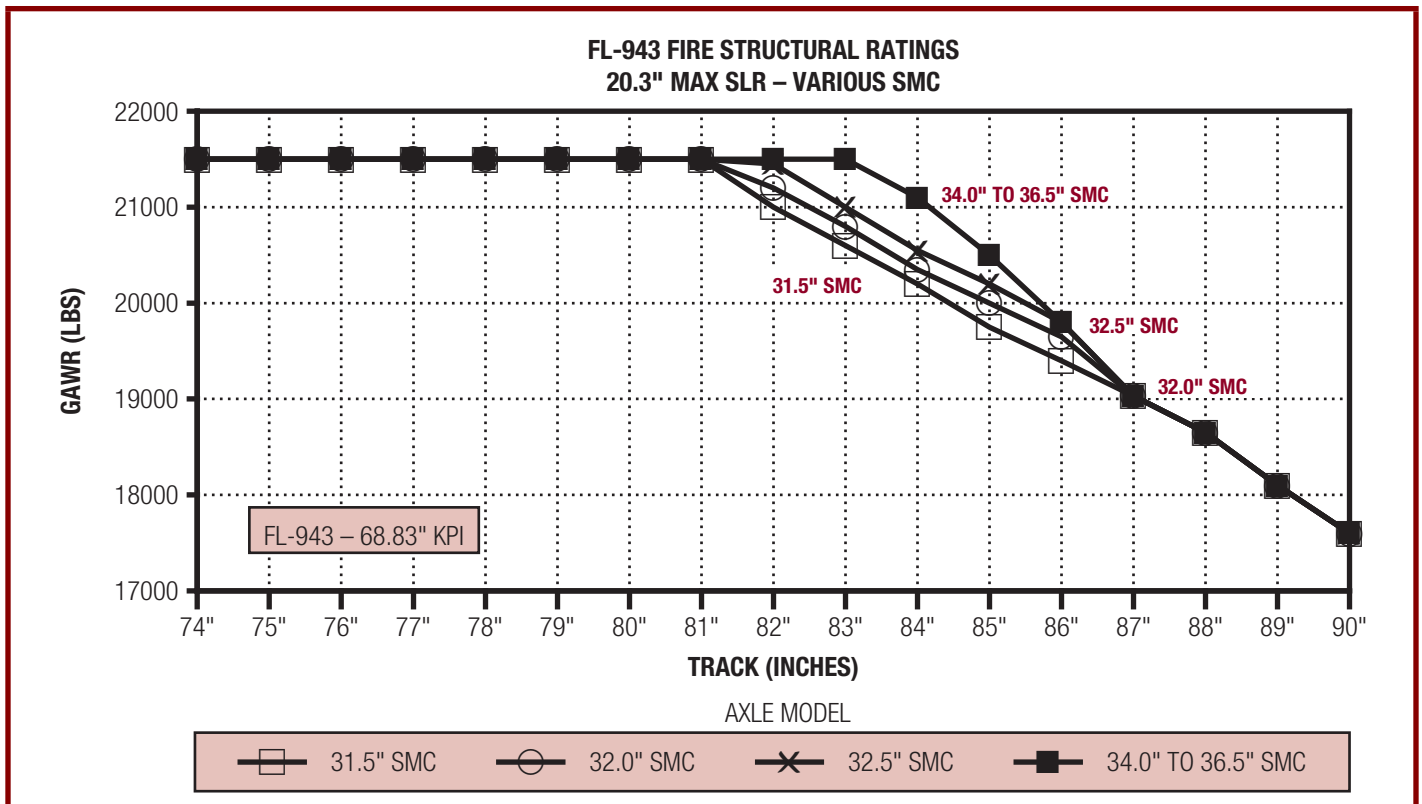
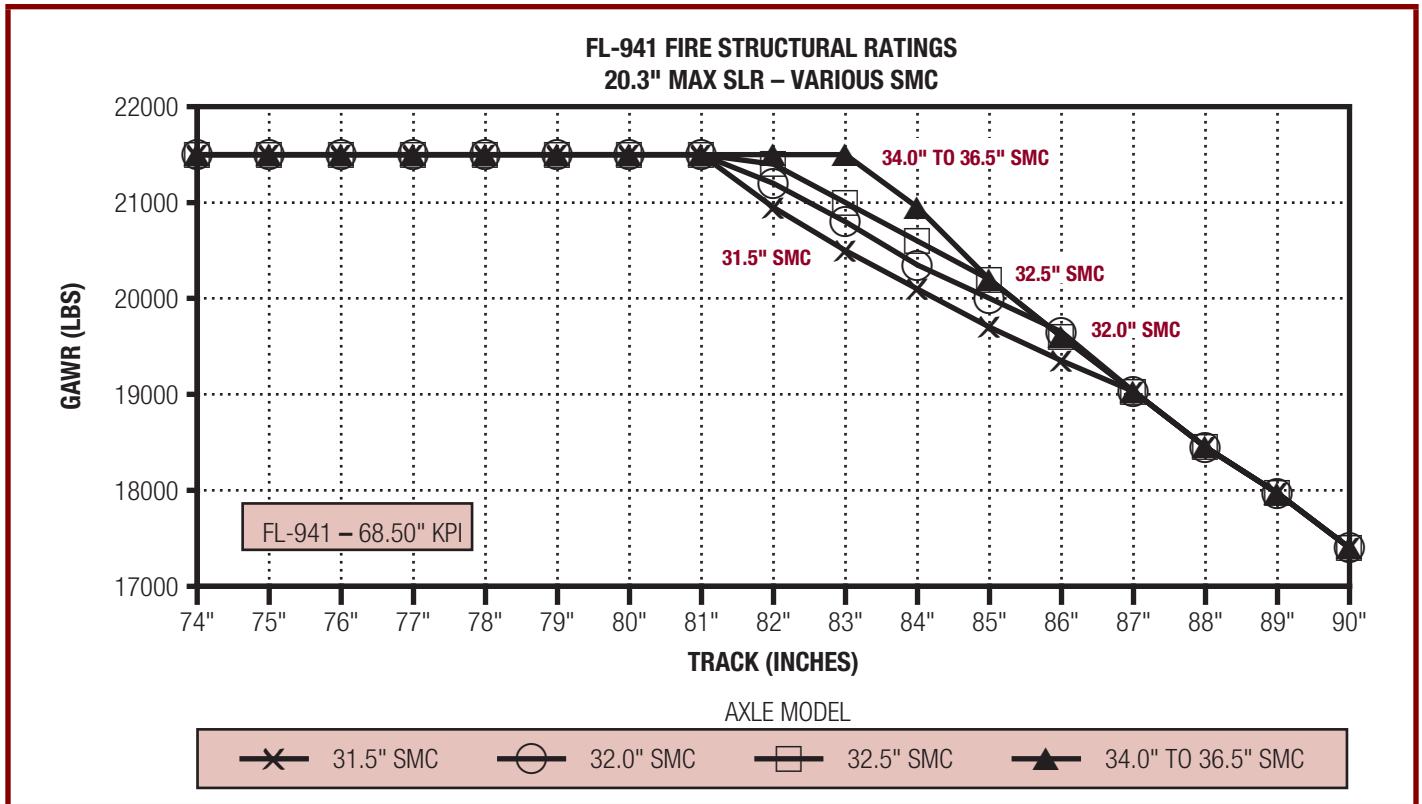

Fire Vocation — Axle Guidelines

Front Drive Steer Axles — Structural Ratings

The approvable area is located on or below each structural curve as follows:

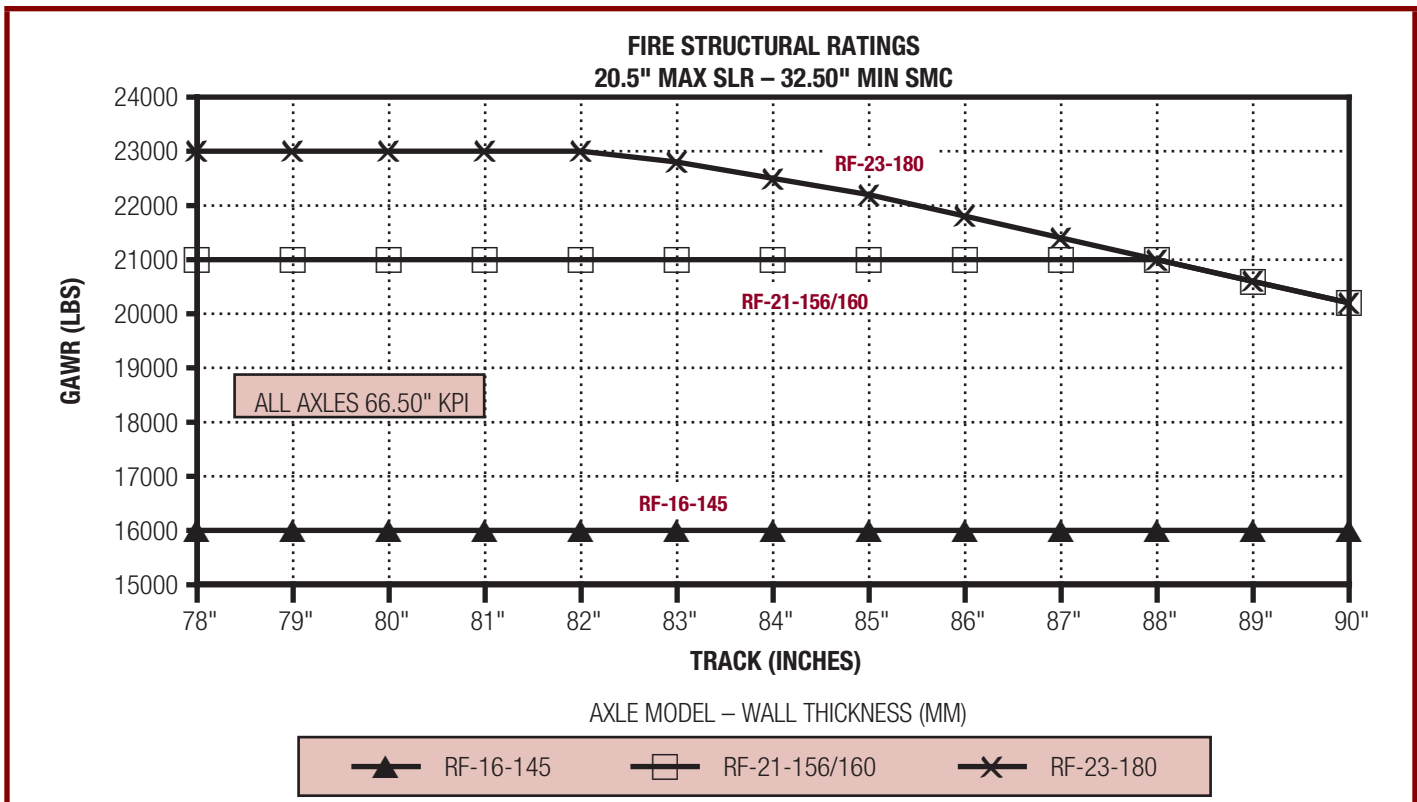
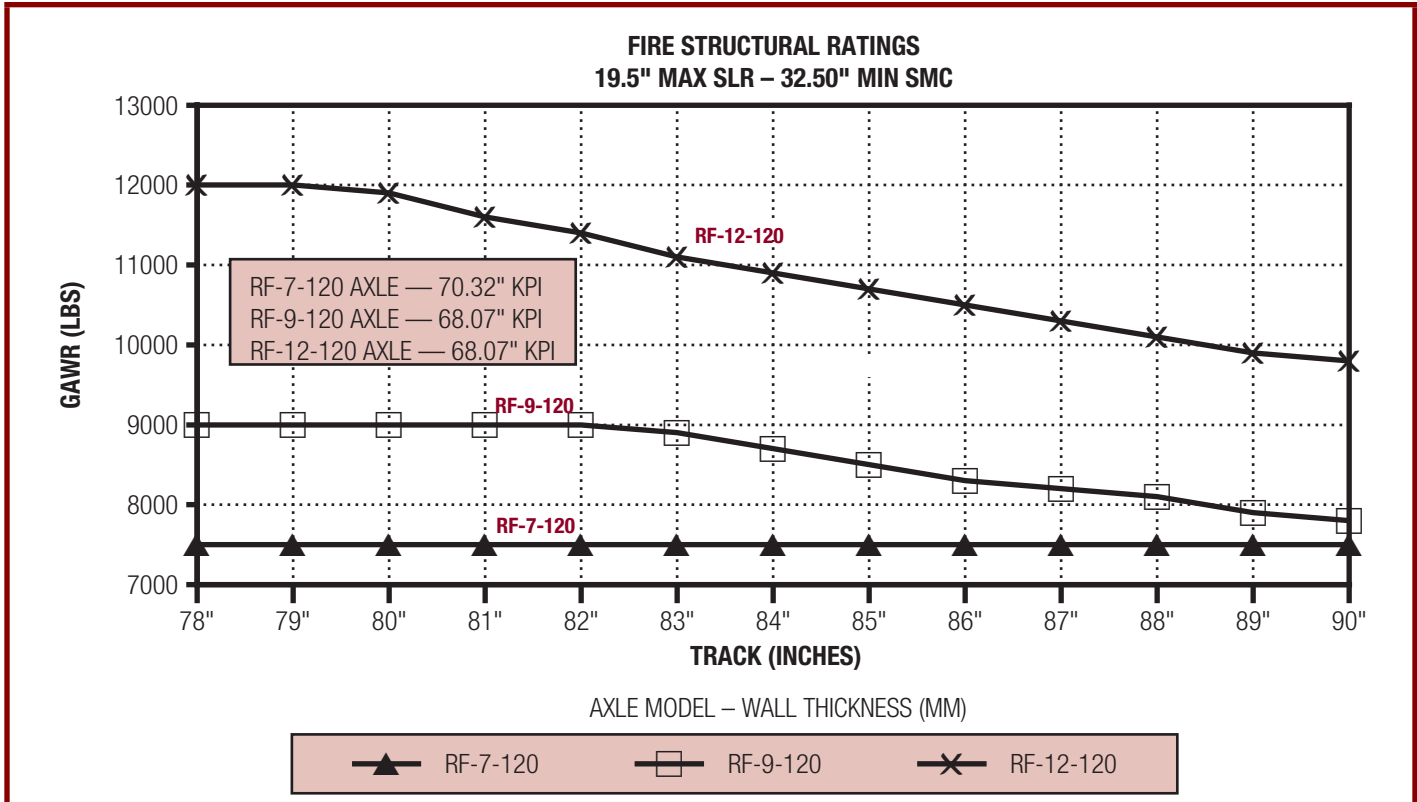

See IMPORTANT NOTE 17 for additional information (Page 23).

Fire Vocation — Axle Guidelines

Single Drive Rear Axles — Structural Ratings

The approvable area is located on or below each structural curve as follows:

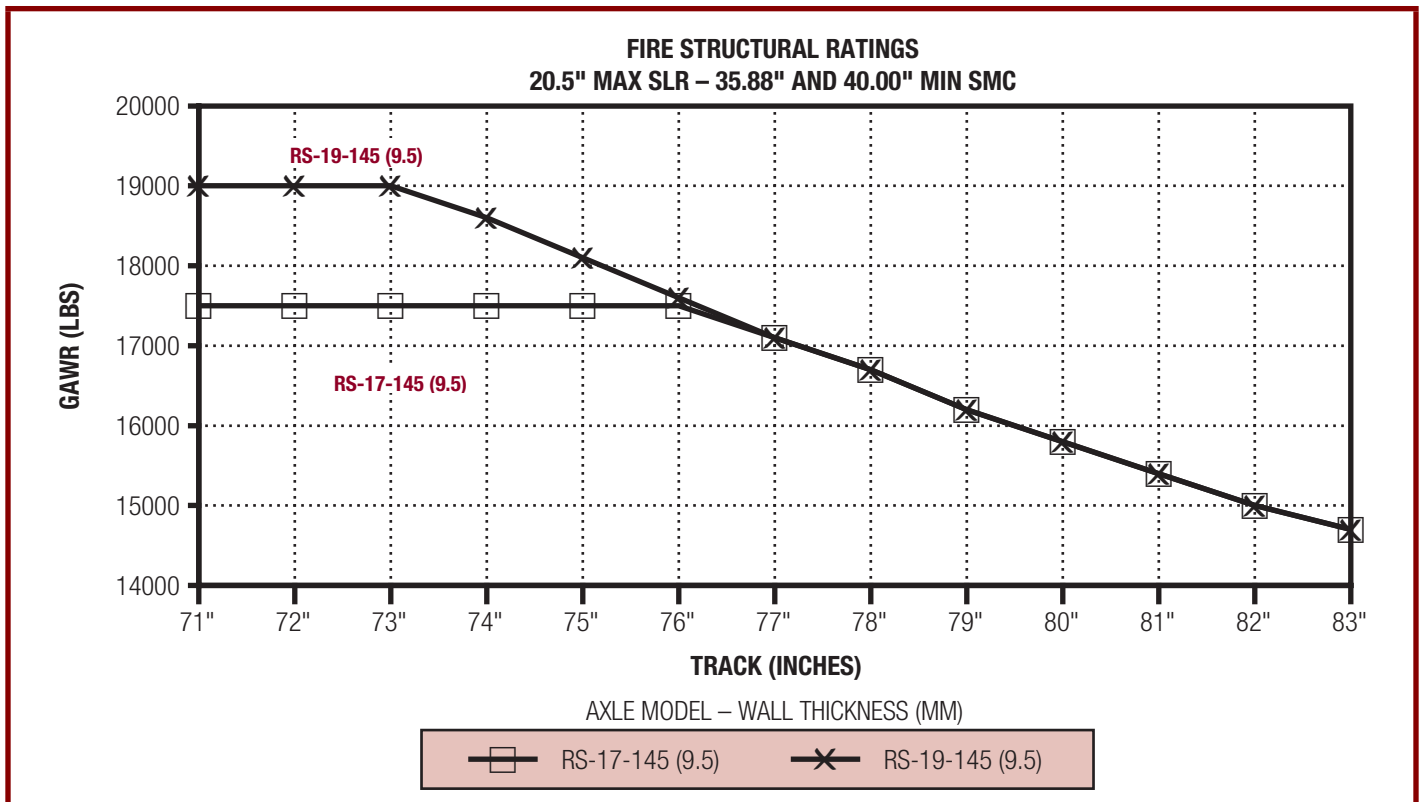
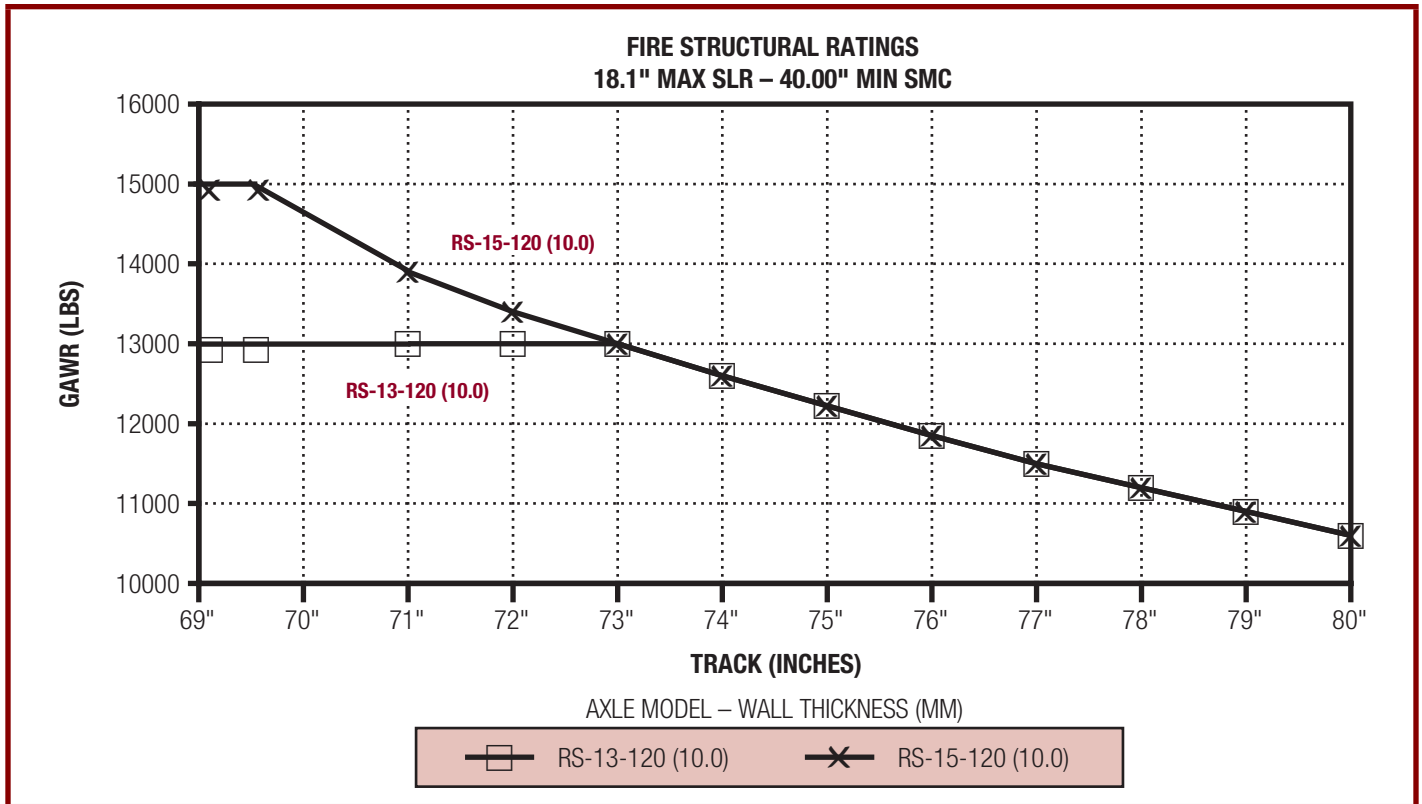

See IMPORTANT NOTE 17 for additional information (Page 23).

Fire Vocation — Axle Guidelines

Single Rear Drive Axles — Structural Ratings

The approvable area is located on or below each structural curve as follows:

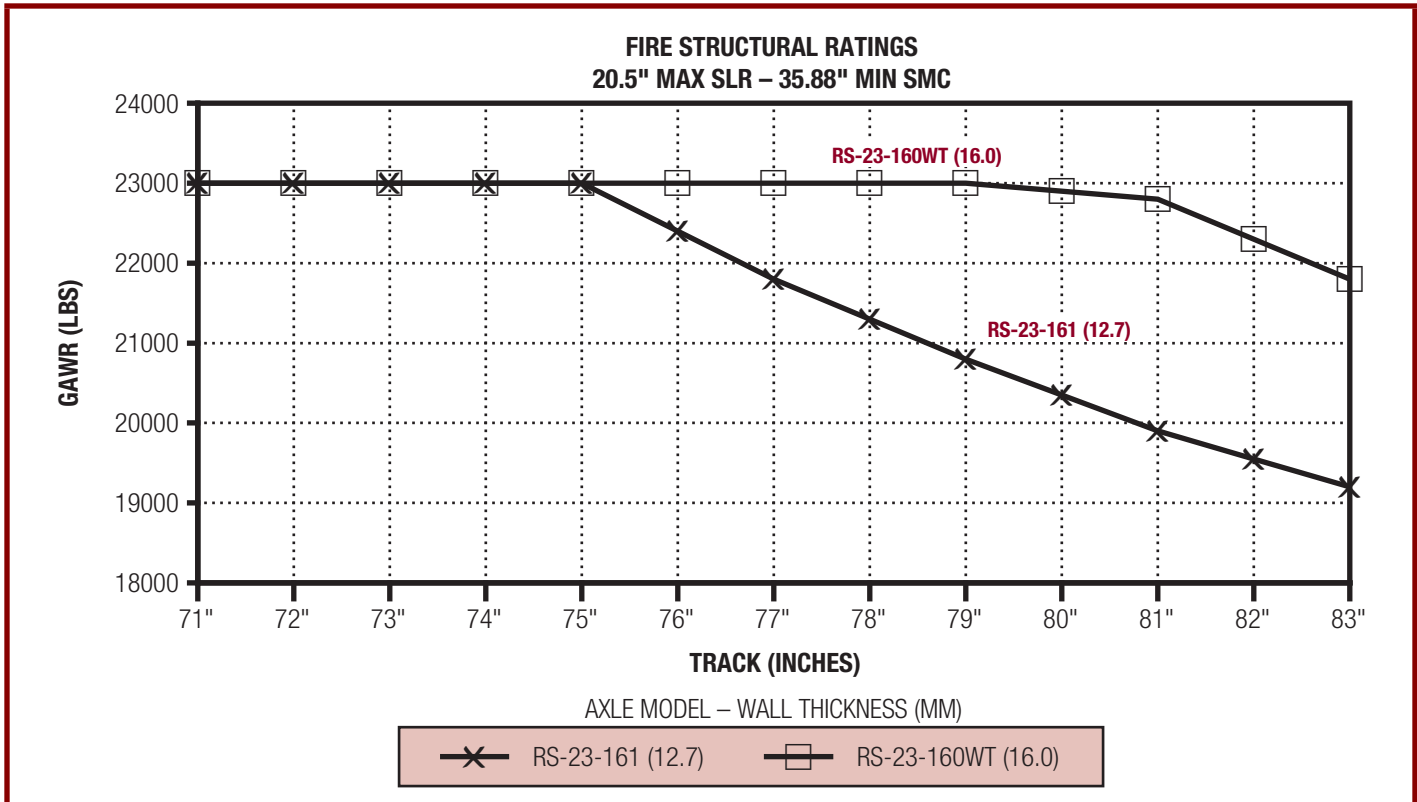
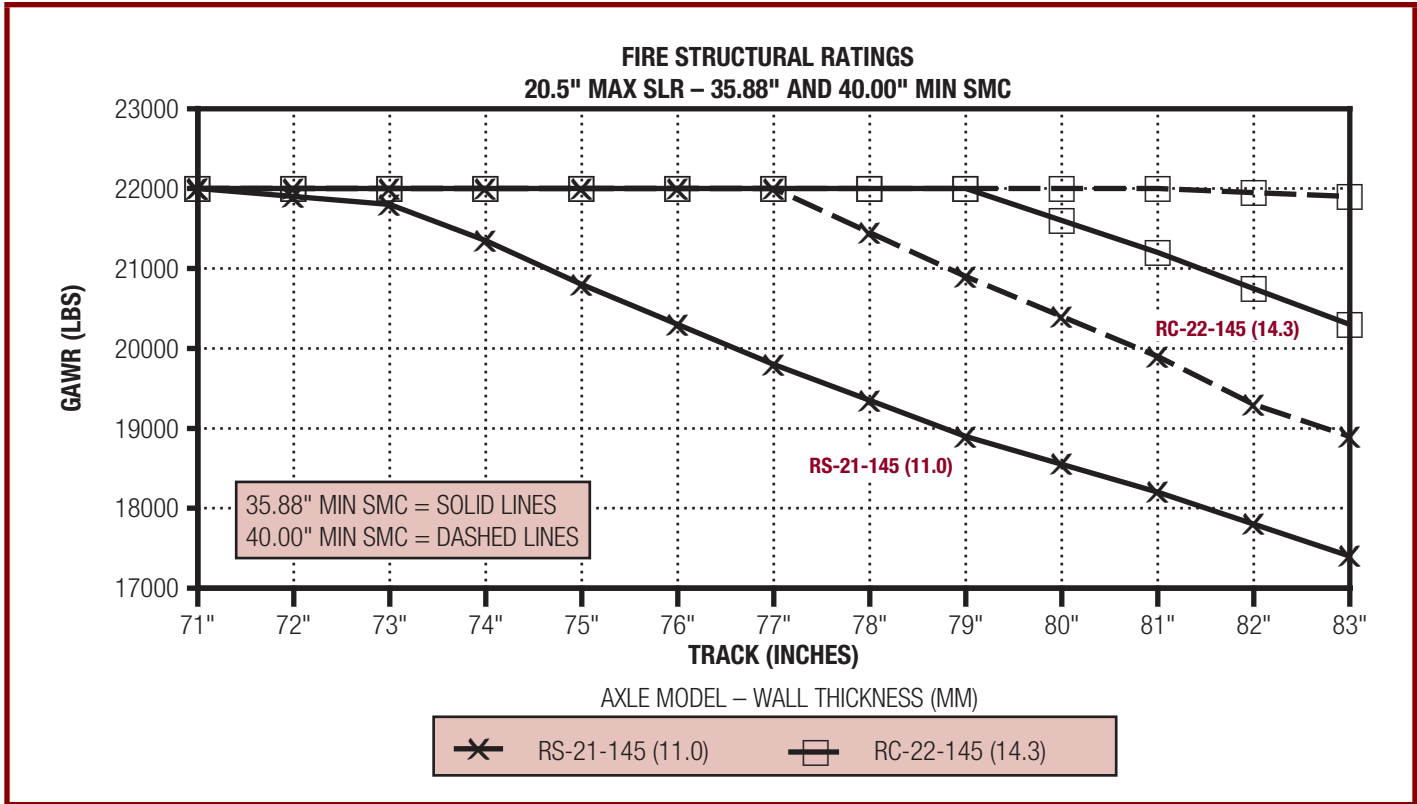

See IMPORTANT NOTES 8 and 17 for additional information (Pages 22 and 23).

WT designates Wide Track Housing Option.

Fire Vocation — Axle Guidelines

Single Rear Drive Axles — Structural Ratings

The approvable area is located on or below each structural curve as follows:

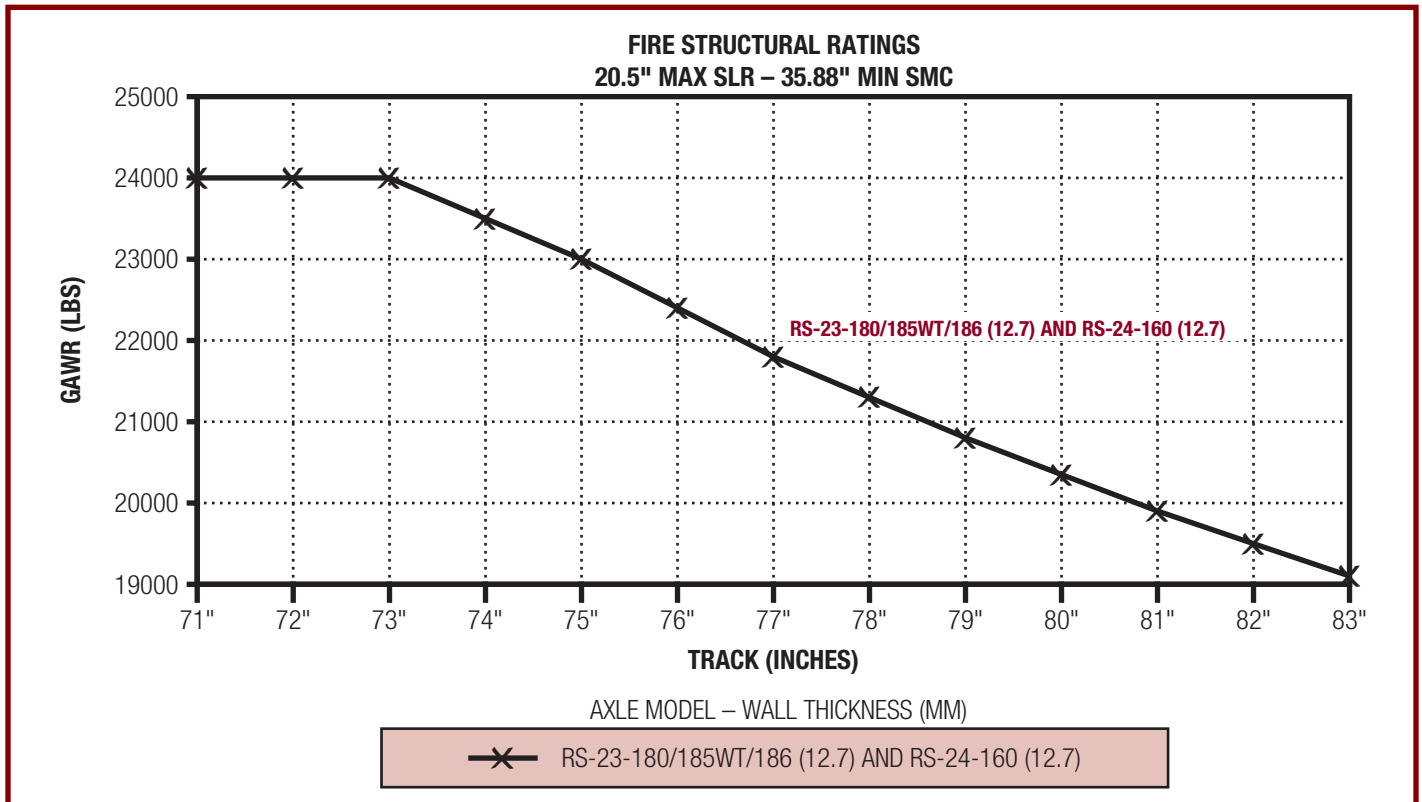
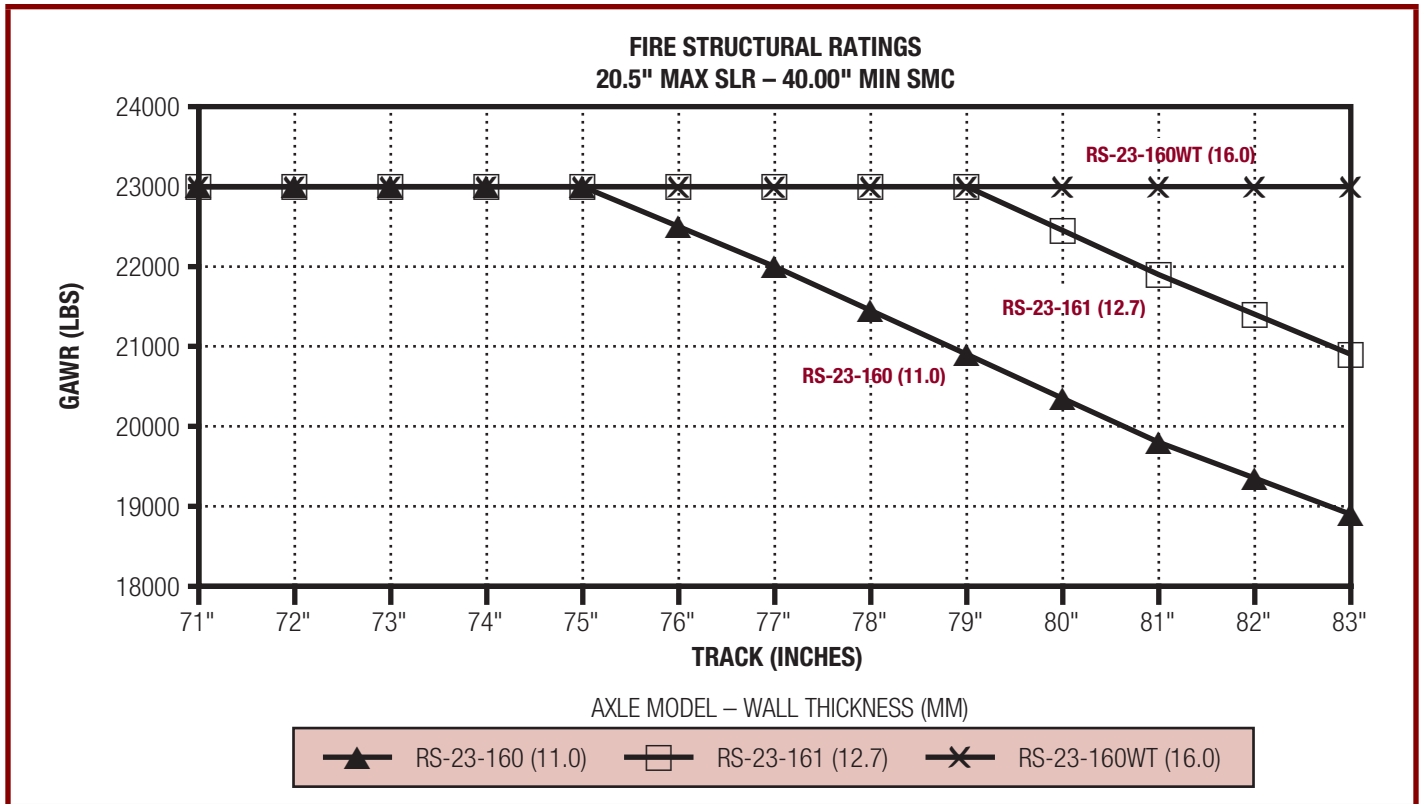

See IMPORTANT NOTES 8, 17 and 21 for additional information (Pages 22, 23 and 24).

WT designates Wide Track Housing Option.

Fire Vocation — Axle Guidelines

Single Rear Drive Axles — Structural Ratings

The approvable area is located on or below each structural curve as follows:

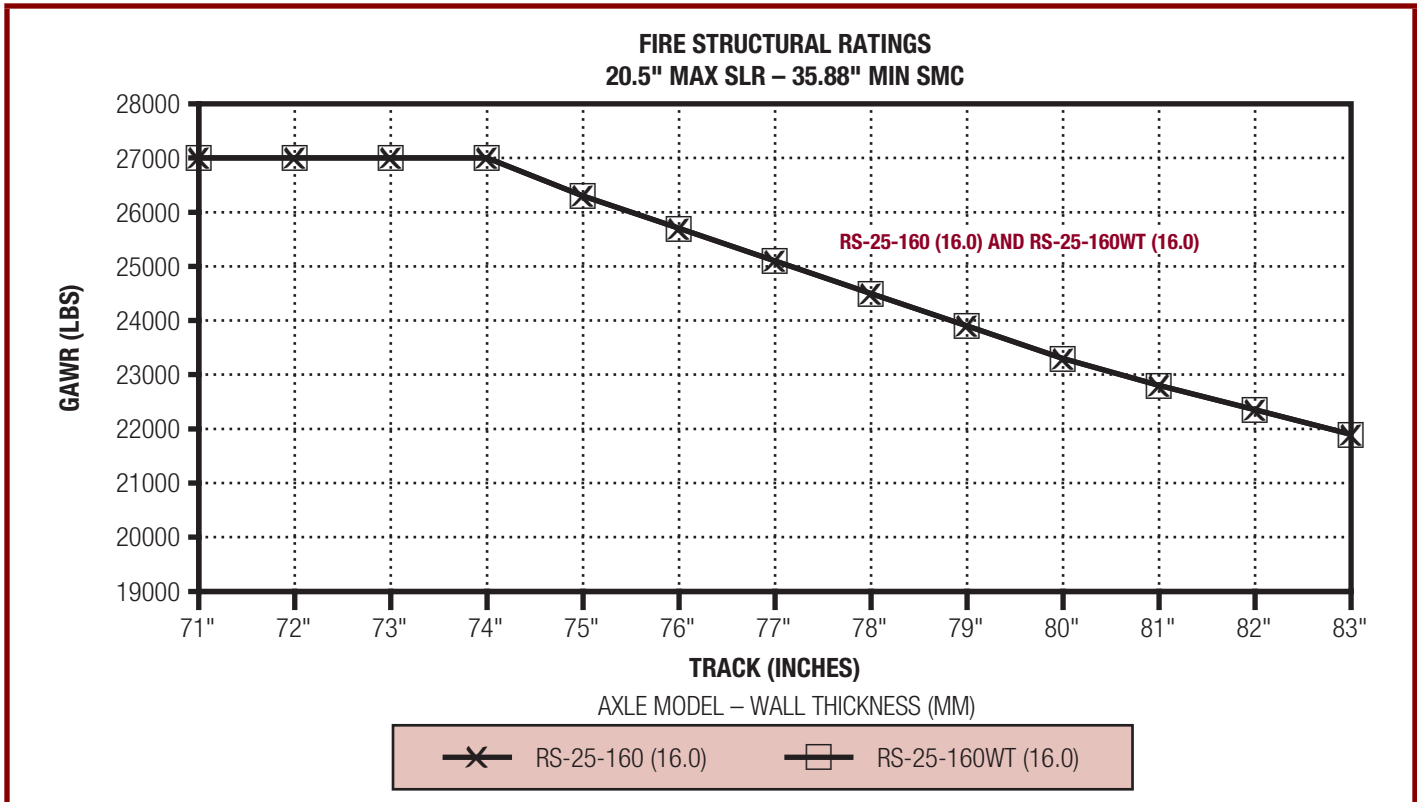
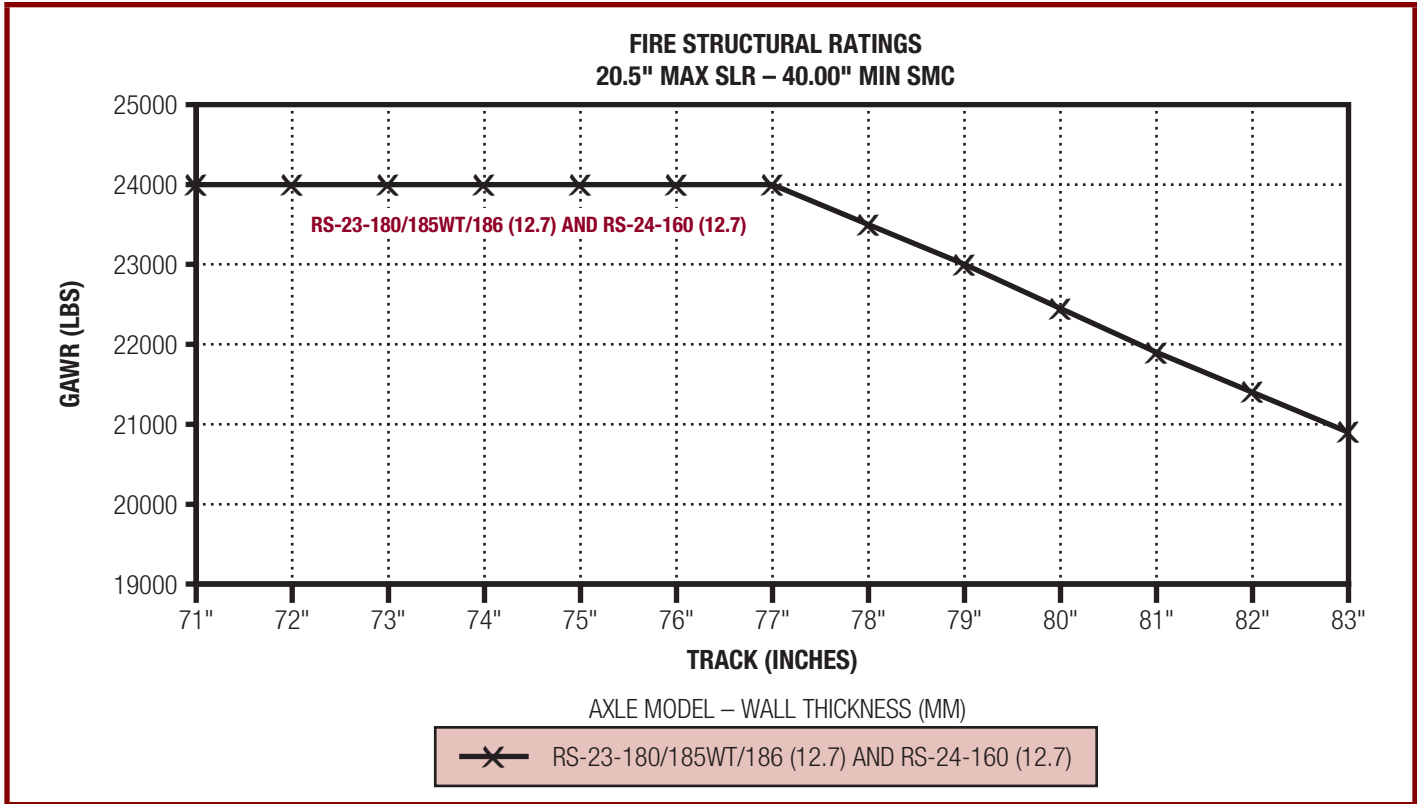

See IMPORTANT NOTES 17 and 21 for additional information (Pages 23 and 24).

WT designates Wide Track Housing Option.

Fire Vocation — Axle Guidelines

Single Rear Drive Axles — Structural Ratings

The approvable area is located on or below each structural curve as follows:

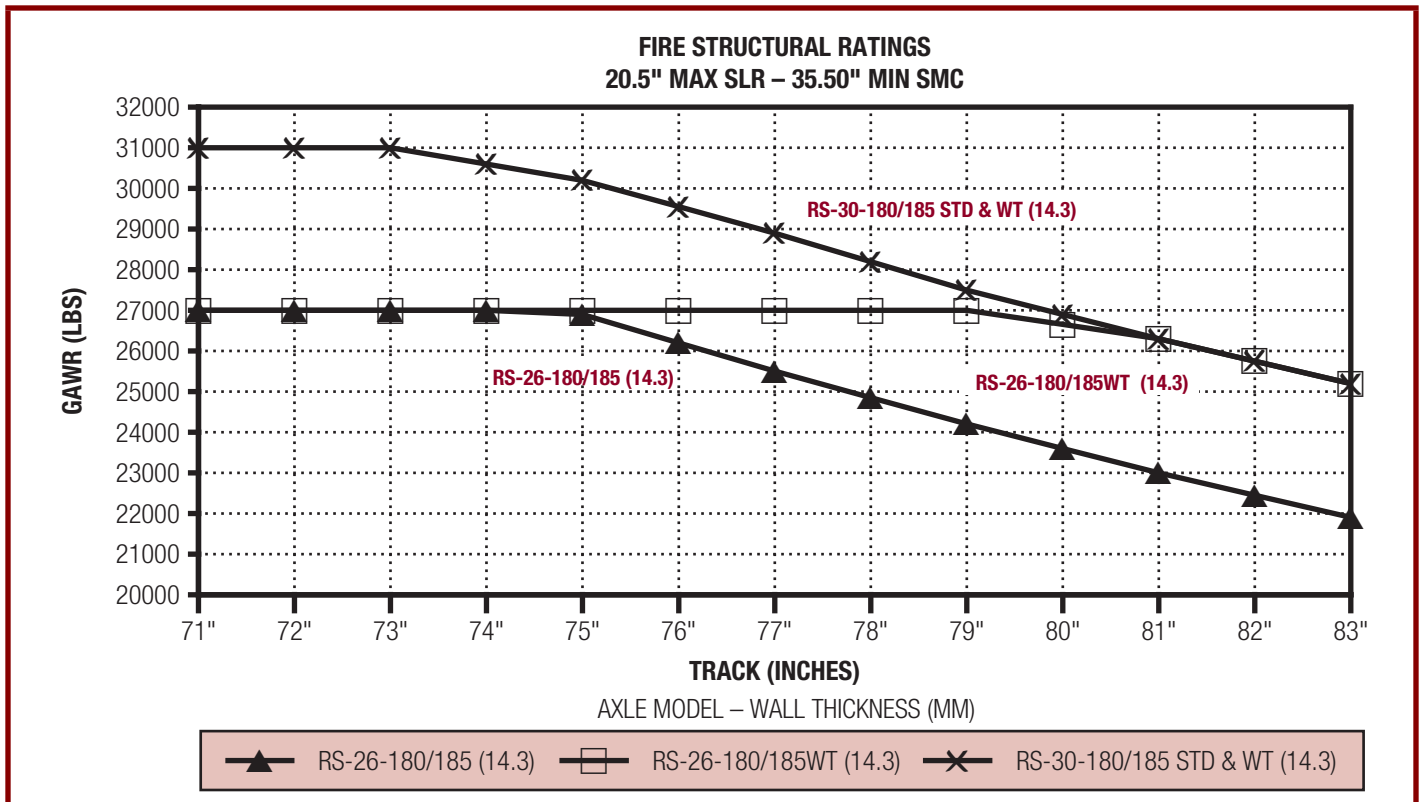
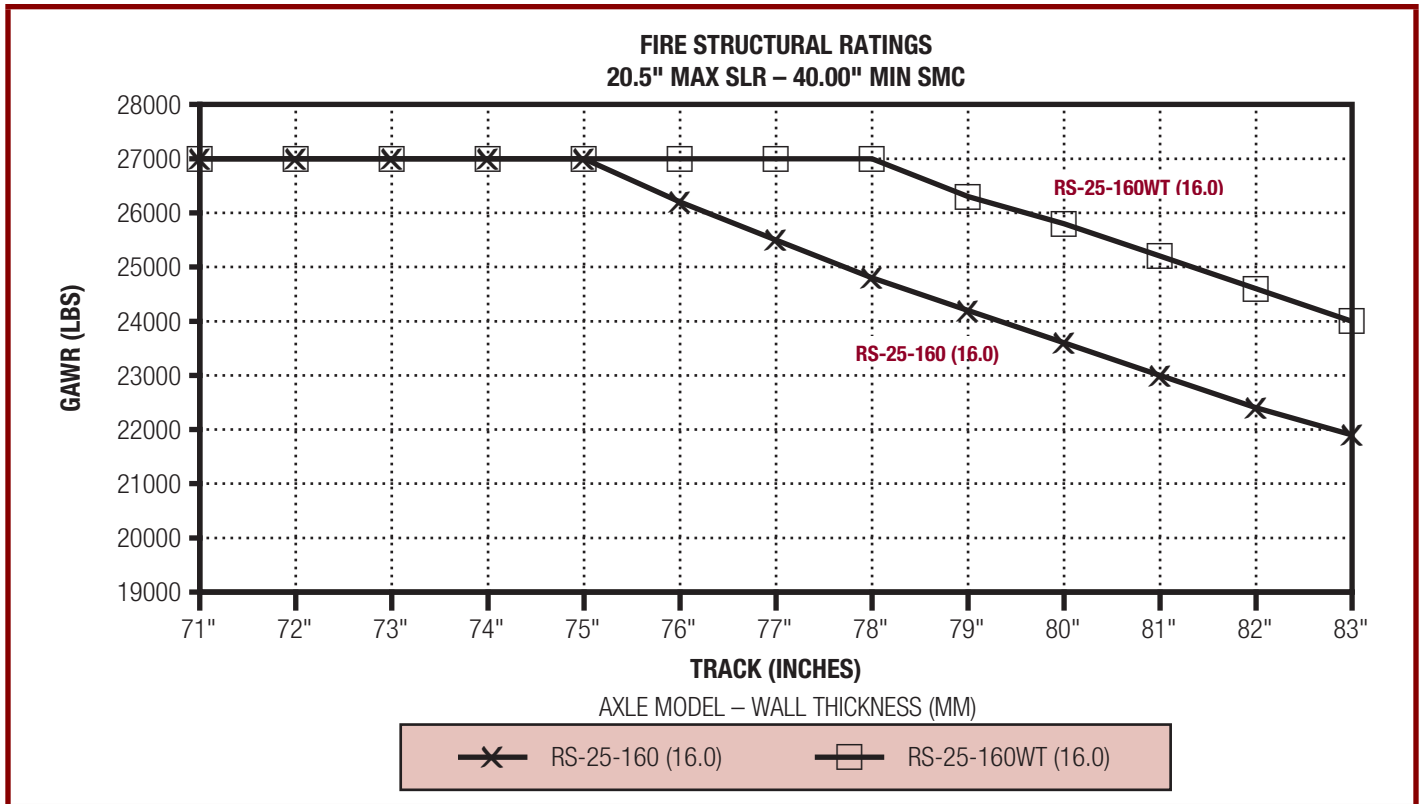

See IMPORTANT NOTES 17 for additional information (Page 23).

WT designates Wide Track Housing Option.

Fire Vocation — Axle Guidelines

Single Rear Drive Axles — Structural Ratings

The approvable area is located on or below each structural curve as follows:

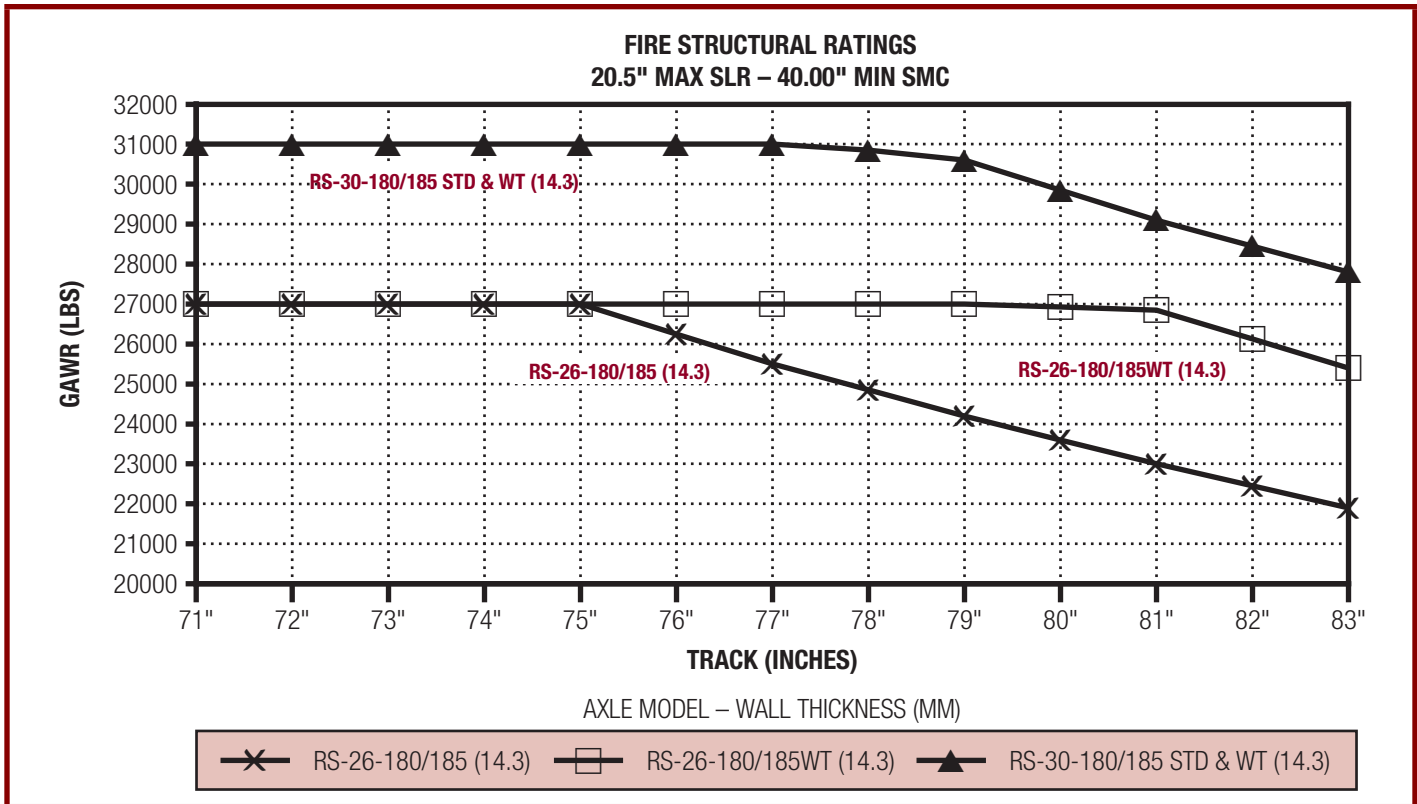

See IMPORTANT NOTES 17 for additional information (Page 23).

WT designates Wide Track Housing Option.

Fire Vocation — Axle Guidelines

Tandem Rear Drive Axles — Structural Ratings

The approvable area is located on or below each structural curve as follows:

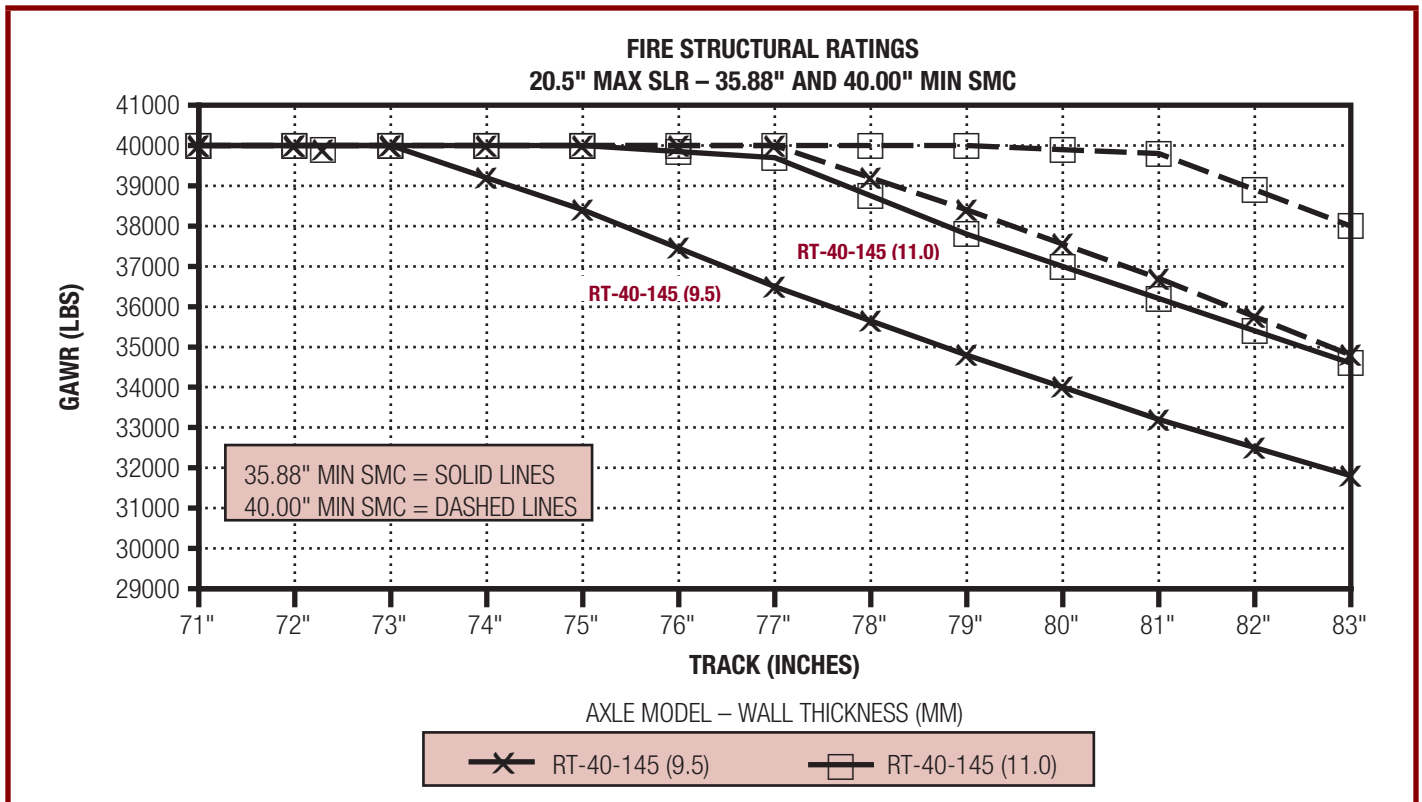
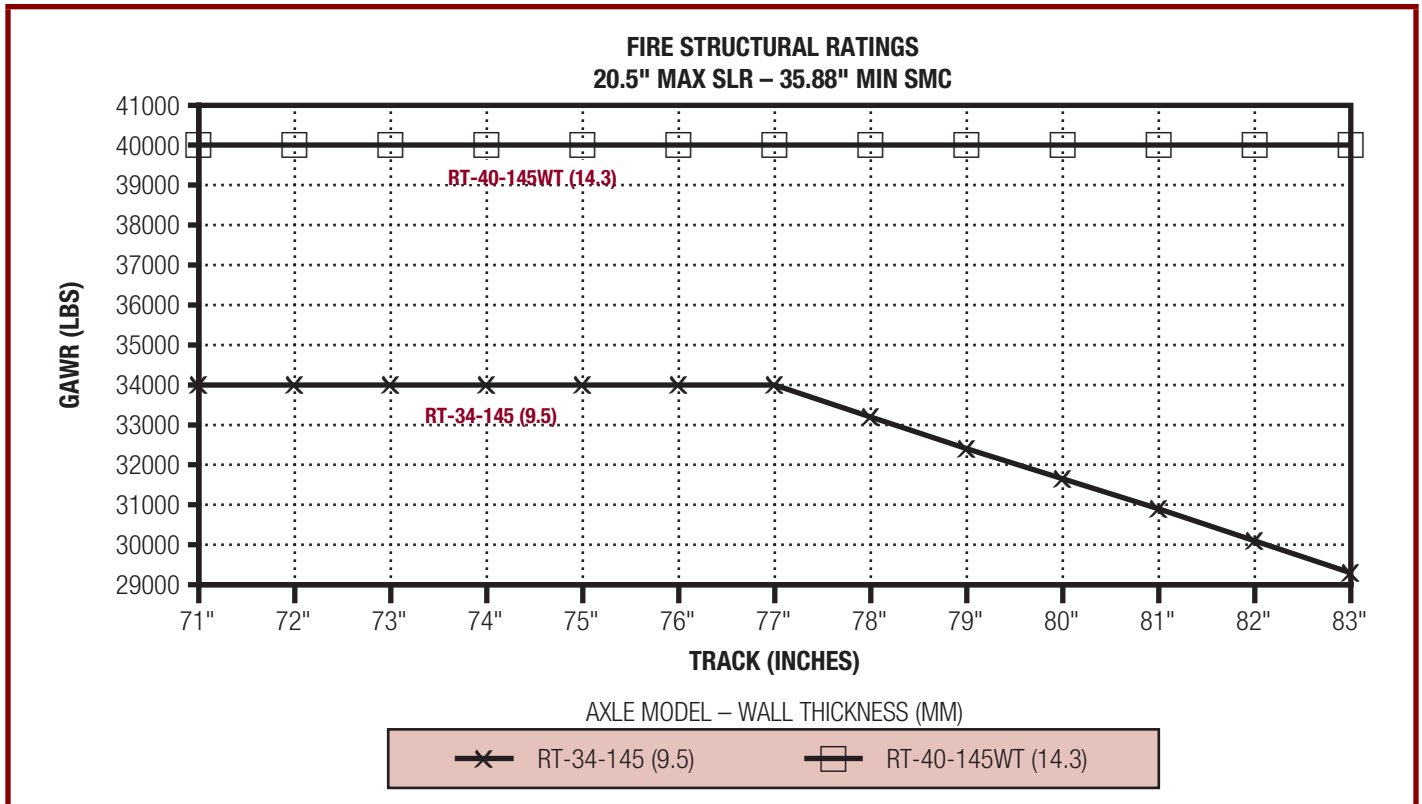

See IMPORTANT NOTES 5 and 17 for additional information (Pages 22 and 23).

WT designates Wide Track Axle Housing Option.

Fire Vocation — Axle Guidelines

Tandem Rear Drive Axles — Structural Ratings

The approvable area is located on or below each structural curve as follows:

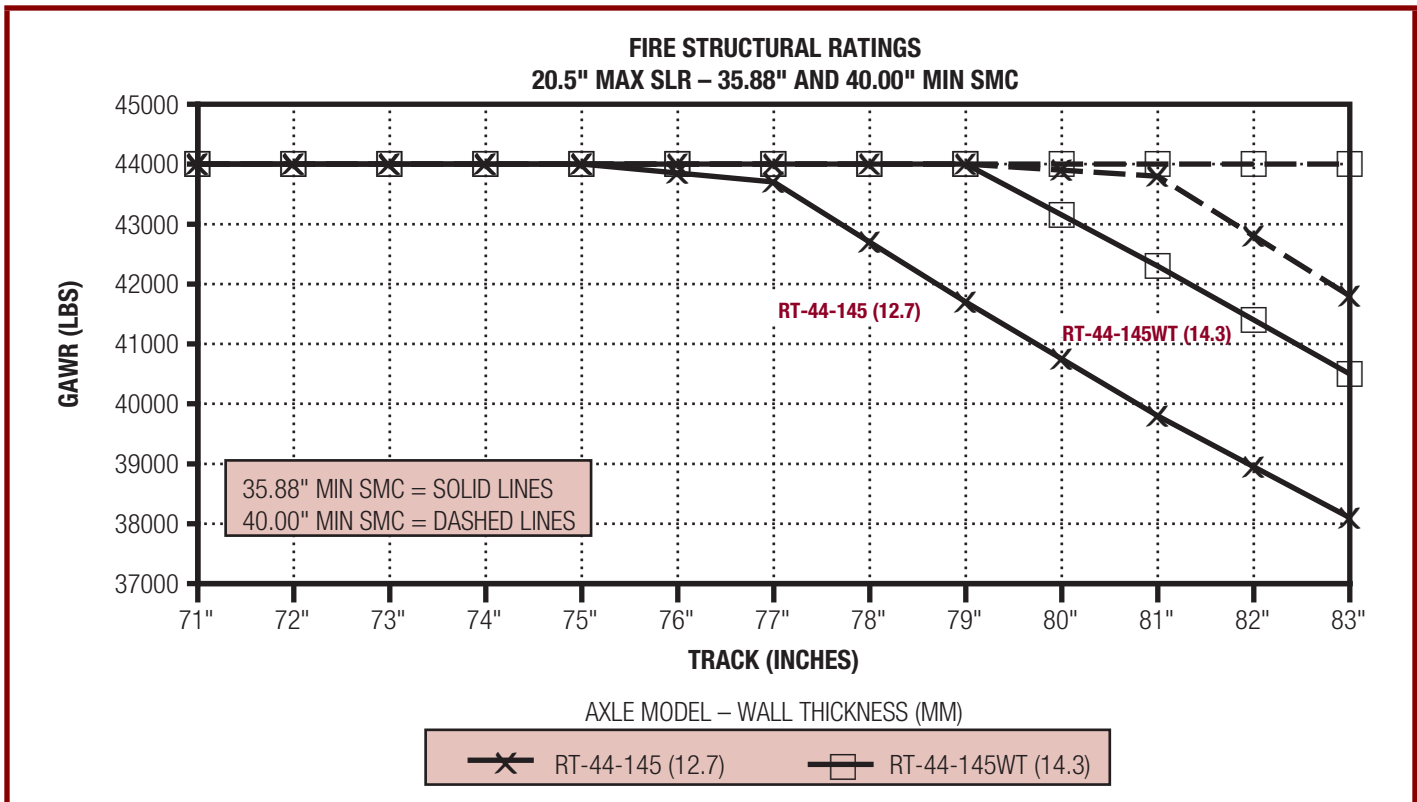
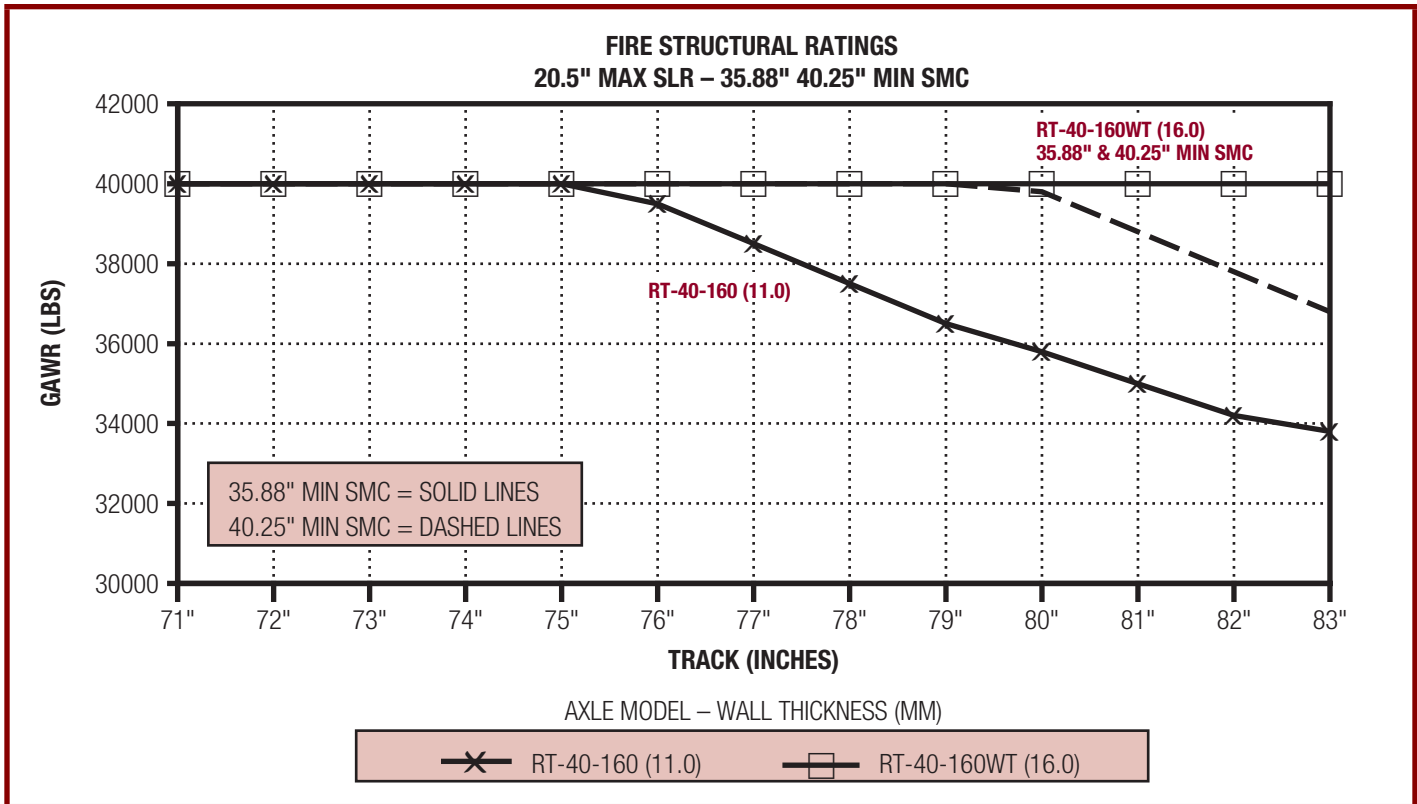

See IMPORTANT NOTE 17 for additional information (Page 23).

WT designates Wide Track Axle Housing Option.

Fire Vocation — Axle Guidelines

Tandem Rear Drive Axles — Structural Ratings

The approvable area is located on or below each structural curve as follows:

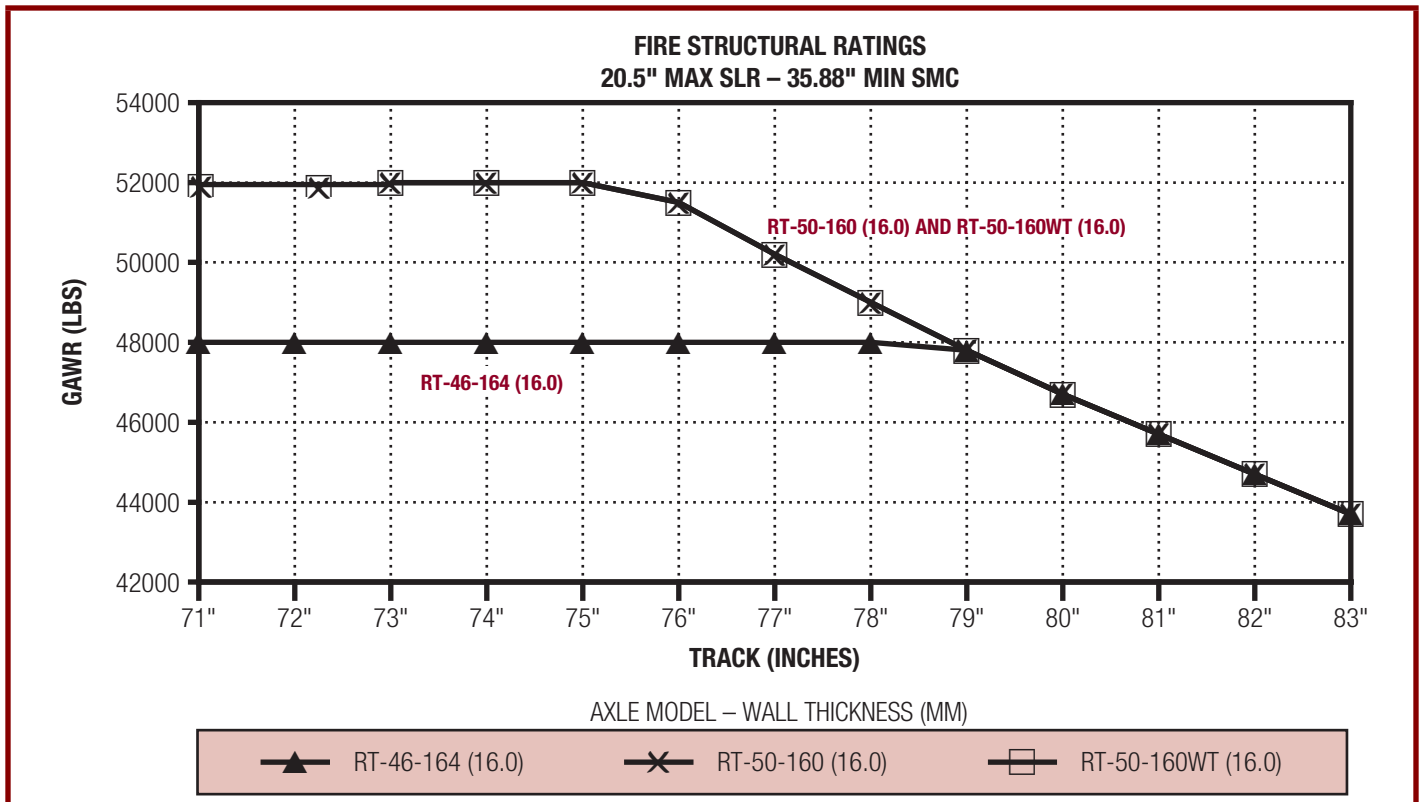
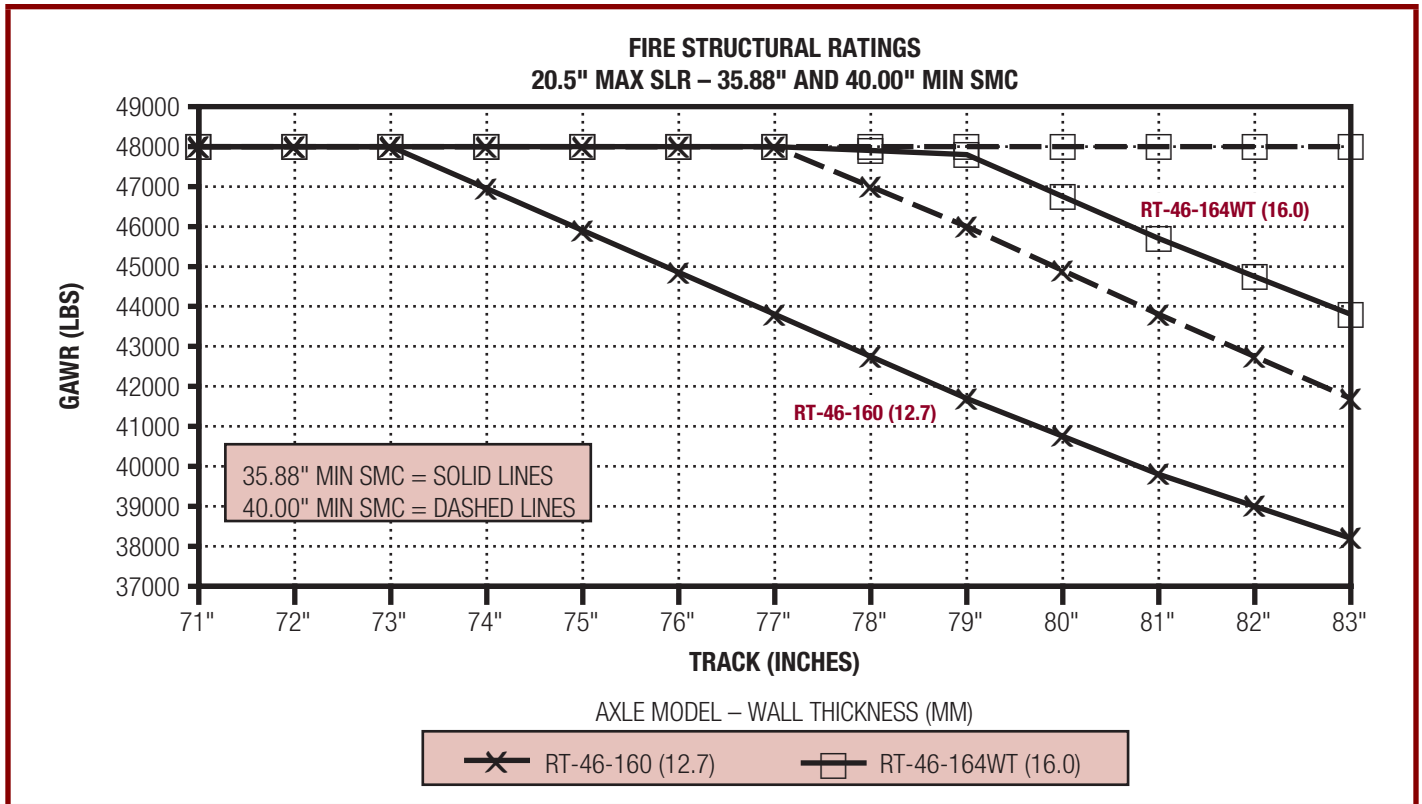

See IMPORTANT NOTE 17 for additional information (Page 23).

WT designates Wide Track Axle Housing Option.

Fire Vocation — Axle Guidelines

Tandem Rear Drive Axles — Structural Ratings

The approvable area is located on or below each structural curve as follows:

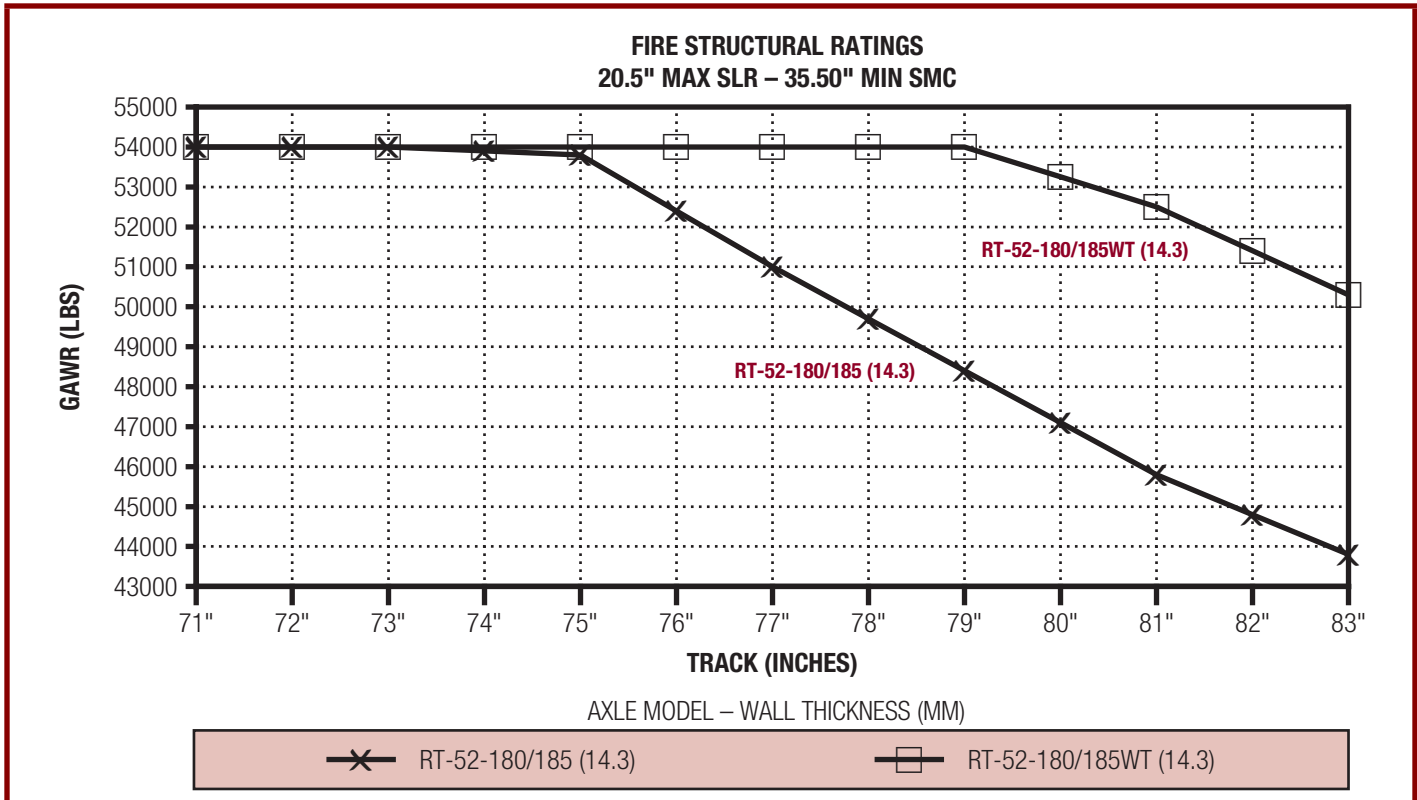
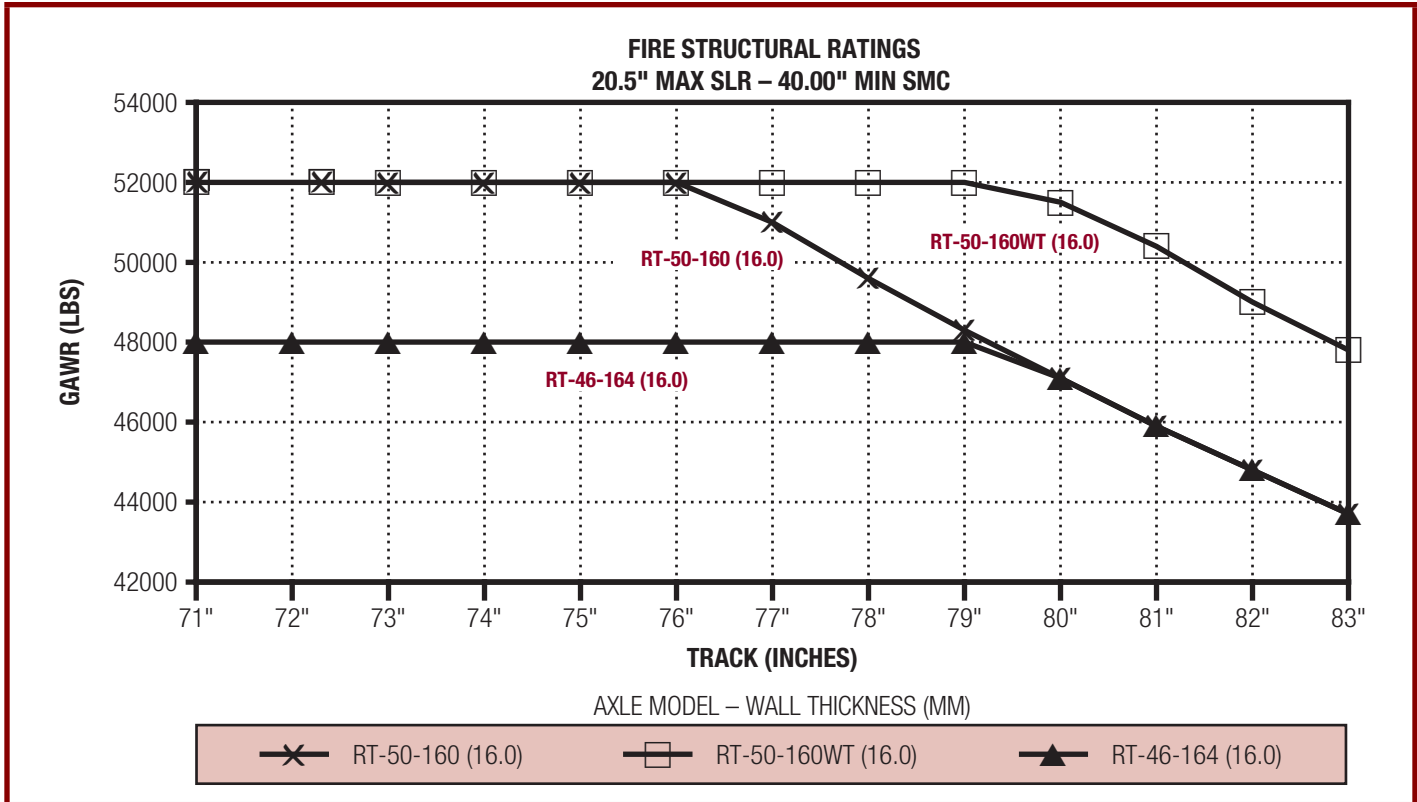

See IMPORTANT NOTE 17 for additional information (Page 23).

WT designates Wide Track Axle Housing Option.

Fire Vocation — Axle Guidelines

Tandem Rear Drive Axles — Structural Ratings

The approvable area is located on or below each structural curve as follows:

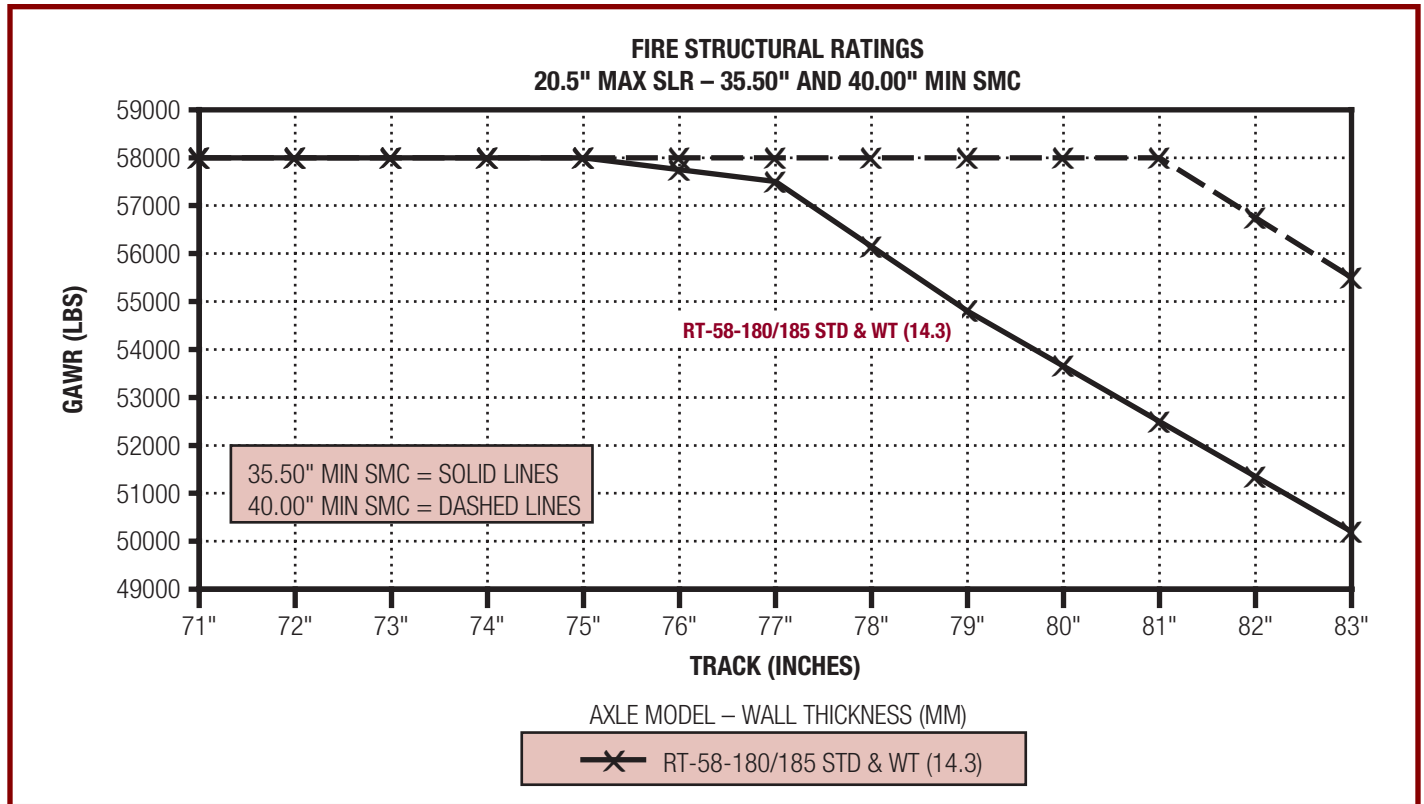

See IMPORTANT NOTE 17 for additional information (Page 23).

WT designates Wide Track Axle Housing Option.

Fire Vocation — Axle Guidelines

Axle Torque Ratings

- **Formula 1** for rear drive axles and **Formula 2** for front drive axles are used to determine **CALCULATED INPUT TORQUE TO AXLE**.

Formula 1	CALCULATED INPUT TORQUE TO AXLE = T x N1 x N2		
Rear Drive Axle	where	T	= Maximum Gross Engine Torque (LB-FT)
		N1	= Lowest Transmission Forward Gear Ratio
		N2	= Torque Converter Stall Ratio
			= 2.5 or specific value for Automatic Transmission
			= 1.0 for Manual Transmission

Formula 2	CALCULATED INPUT TORQUE TO AXLE = T x 0.5 x N1 x N2		
Front Drive Axle	where	T	= Maximum Gross Engine Torque (LB-FT)
All-Wheel-Drive with Transfer Case		N1	= Lowest Transmission Forward Gear Ratio
		N2	= Torque Converter Stall Ratio
			= 2.5 or specific value for Automatic Transmission
			= 1.0 for Manual Transmission

- Axles used with engines having more than 875 LB-FT (for RS-120), 1100 LB-FT (for RC/RS-145), 1650 LB-FT (for RT-145) or 1850 LB-FT (for RS/RT-16x, RS-18x and RT-18x) Maximum Gross Engine Torque are not approved by this Axle Guideline. Contact Meritor Axle Engineering for possible approval.
- Calculated values of input torque to axle which are outside the limits of the Axle Torque Ratings shown within this Axle Guideline may be approvable (i.e., **Torque Limiting Devices**). Contact Meritor Axle Engineering for possible approval.
- This Axle Guideline applies to drive side loaded rear axle gearing. If coast side loaded rear axle gearing is desired, contact Meritor Axle Engineering for possible approval.
- All-wheel-drive vehicles will usually incorporate Transfer Cases into their powertrains. For the purpose of simplification, the Transfer Case ratios are not to be used in the above formula. For complete information on Transfer Case selection procedures refer to the TRANSFER CASE GUIDELINE.
- The chart on pages 19-20 is to be used to determine axle torque limits approved for the identified Meritor axle models by available ratio.

See IMPORTANT NOTES 12-17 for additional information (Page 23).

Fire Vocation — Axle Guidelines

Axle Torque Ratings For Fire					
Axle	MAXIMUM ALLOWABLE INPUT TORQUE TO AXLE (LB-FT)				
	Front Drive				
	RF-120	RF-145	RF-156	RF-160	RF-180
Ratio					
3.07	x	xx	x	20,400	x
3.08	x	x	x	x	21,800
3.21	x	xx	x	20,400	22,300
3.31	6,500	x	x	x	x
3.42	x	12,300	x	20,400	22,300
3.58	5,700	10,900	x	20,200	21,400
3.73	6,100	10,800	x	20,200	21,400
3.91	4,900	9,900	x	20,200	21,400
4.10	5,300	9,500	19,000	20,200	21,400
4.30	4,400	x	x	18,600	19,700
4.33	x	9,200	x	x	x
4.56	4,500	x	15,400	16,800	18,900
4.63	x	9,200	15,800	x	x
4.88	4,200	8,800	x	x	x
4.89	x	x	12,800	15,000	15,300
5.13	3,900	7,800	x	x	16,400
5.29	3,600	8,000	13,400	x	x
5.38	x	x	12,000	12,600	14,700
5.57	3,500	7,000	x	x	x
5.63	x	x	x	11,200	12,500
5.86	3,200	6,000	x	x	13,800
6.14	2,600	5,700	11,600	9,800	11,600
6.43	x	5,200	x	8,600	x
6.83	2,300	4,900	8,200	8,600	9,900
7.17	2,000	4,500	x	7,800	8,900
7.40	x	x	8,600	x	10,200

NOTES:

- 1) Axle torque ratings charted above are to be used only with guidelines for Fire Vocation.
- 2) Calculated Input Torque to Axle (per formula) must be less than Maximum Allowable Input Torque to Axle (per chart).
- 3) Maximum engine torques greater than 875 lb-ft (for RS-120), 1100 lb-ft (for RC/RS-145), 1650 lb-ft (for RT-145) or 1850 lb-ft (for RS/RT-16x, RS-18x and RT-18x) are not approved by this guideline. Contact Meritor Axle Engineering for possible approval.
- 4) x = Ratio not available.
- 5) xx = Contact Meritor Axle Engineering for possible approval.
- 6) Ratio for RF-156 is 4.11 and 6.17.

Fire Vocation — Axle Guidelines

Axle Torque Ratings For Fire							
Axle	MAXIMUM ALLOWABLE INPUT TORQUE TO AXLE (LB-FT)						
	Single Rear Drive				Tandem Rear Drive		
	RS-120	RC/RS-145	RS-16x	RS-18x	RT-145	RT-16x	RT-18x
Ratio							
3.07	x	xx	21,000	x	xx	30,000	x
3.08	x	x	x	22,500	x	x	x
3.21	x	xx	21,000	23,000	xx	30,000	x
3.31	6,700	x	x	x	x	x	x
3.42	x	12,700	21,000	23,000	23,000	30,000	x
3.58	5,900	11,300	20,800	22,100	22,100	30,000	x
3.73	6,300	11,200	20,800	22,100	22,100	30,000	30,000
3.91	5,100	10,200	20,800	22,100	22,100	30,000	x
4.10	5,500	9,800	20,800	22,100	22,100	30,000	30,000
4.30	4,600	x	19,100	20,300	x	30,000	30,000
4.33	x	9,500	x	x	21,800	x	x
4.56	4,700	x	17,400	19,500	x	30,000	30,000
4.63	x	9,500	x	x	20,400	x	x
4.88	4,400	9,000	x	x	18,000	x	x
4.89	x	x	15,500	15,800	x	30,000	30,000
5.13	4,100	8,200	x	16,900	x	x	x
5.29	3,800	8,300	x	x	16,600	x	x
5.38	x	x	13,100	15,200	x	26,200	30,000
5.57	3,700	7,200	x	x	x	x	x
5.63	x	x	11,500	12,900	x	23,000	x
5.86	3,300	6,100	x	14,200	12,200	x	x
6.14	2,700	5,900	10,200	12,000	11,800	20,400	24,000
6.43	x	5,400	8,900	x	10,800	17,800	x
6.83	2,400	5,100	8,900	10,200	10,200	17,800	20,400
7.17	2,100	4,700	8,000	9,200	9,400	16,000	18,400
7.40	x	x	x	10,500	x	x	x

NOTES:

- 1) Axle torque ratings charted above are to be used only with guidelines for Fire Vocation.
- 2) Calculated Input Torque to Axle (per formula) must be less than Maximum Allowable Input Torque to Axle (per chart).
- 3) Maximum engine torques greater than 875 lb-ft (for RS-120), 1100 lb-ft (for RC/RS-145), 1650 lb-ft (for RT-145) or 1850 lb-ft (for RS/RT-16x, RS-18x and RT-18x) are not approved by this guideline. Contact Meritor Axle Engineering for possible approval.
- 4) x = Ratio not available.
- 5) xx = Contact Meritor Axle Engineering for possible approval.
- 6) Ratio for RF-156 is 4.11 and 6.17.

Fire Vocation — Axle Guidelines

GVW Ratings

This chart lists maximum GVW for Meritor axle (by model) for the duty cycle outlined in this **AXLE GUIDELINE**.

MAX GVWS (LBS) BY AXLE MODEL

DUTY I		(20% Max Grades) 100% Loaded Full Time
Axle Model	GVW Ratings	
RS-13-120	23,000	
RS-15-120	25,000	
RS-17-145	29,500	
RS-19-145	31,000	
RS-21-145	42,000	
RC-22-145	42,000	
RS-23-160	44,500	
RS-23-161	44,500	
RS-23-186/180	45,500	
RS-24-160	45,500	
RS-25-160	48,500	
RS-26-185/180	48,500	
RS-30-185/180	52,500	
RT-34-145	55,500	
RT-40-145	61,500	
RT-44-145	65,500	
RT-46-160	69,500	
RT-50-160	73,500	
RT-52-185/180	75,500	
RT-58-185/180	79,500	

See IMPORTANT NOTE 10 for additional information (Page 23).

Fire Vocation — Axle Guidelines

Important Notes

1. The following optional components are approved by this **AXLE GUIDELINE**. All options may not be available on all axle models:
 - a. **Driver-Controlled Differential Lock (DCDL)**
 - b. **ABS**
 - c. **Oil Pump**
 - d. **Advanced Lube**
2. The use of **NoSPIN** “differentials” in any single or tandem rear drive axle will result in the exclusion of axle shafts from warranty considerations. Certain other carrier components will also be excluded from warranty considerations if their failure is deemed the result of a NoSPIN failure or malfunction. Depending on axle loading, the NoSPIN can cause all differential torque to be directed to one axle shaft causing overload (and potential failure). NoSPIN is a product of Tractech, a Titan Wheel International Company.
3. For approval of Meritor **Transmission, Clutch, Driveline, Brake, Retarders, Wheel End, Trailer Axles** and all other components contact the appropriate Meritor engineering function: 800-535-5560.
4. **Transfer Case** configurations must be matched to specific OEM installations. To gain approval each installation should be reviewed by Meritor’s Application Engineering Group. Preliminary product selection can be approximated by reviewing the Transfer Case Guideline.
5. For certain **Suspension** models, Meritor requires the use of an increased housing wall thickness. See Meritor Product Information Letter No. 134 or contact Meritor Axle Engineering for clarification.
6. For details on Meritor’s **Advanced Lubrication Program** consult Meritor Technical Publication TP-9303 or Maintenance Manual MM No. 1.
7. Vehicles equipped with multiple **Retarders** of any type (engine brake, exhaust brake, hydraulic transmission, chassis mounted or axle mounted electromagnetic) must be approved by Meritor as well as the manufacturers of the selected retarders. Contact Meritor Axle Engineering for possible approval. Vehicles with single retardation devices are approvable.
8. For additional **RS-23-160** and **RS-23-161** guidelines, refer to Meritor Product Information Letter No. 117 or contact Meritor Axle Engineering for clarification.
9. Meritor Automotive’s Axle Application Approval, with respect to the **Suspension** selected, is limited to the location of the suspension attaching positions relative to those parameters (track, tire, mounting centers, etc.) specified. Attachment to the axle housing assembly and durability of the axle housing assembly as a result of suspension loadings on the housing, is the responsibility of the OEM. Meritor assumes responsibility of the bracket integrity and attachment only if:
 - a. The brackets are attached by Meritor or,
 - b. Meritor has established a prior agreement with the OEM.

Fire Vocation — Axle Guidelines

Important Notes (Cont'd.)

10. It is the responsibility of the OEM and/or the dealer to accurately convey all approved axle loading information to the **Body Builder** if the chassis is sold as incomplete. It is also the responsibility of the final vehicle builder to insure the assigned tagged values for GAWR and GVW/GCW do not exceed those limits approvable by this vocational guideline.
11. The **OEM has the responsibility** to determine Steering Axle Specifics (Maximum Turn Angle, Tie Rod Arm Selection, Steering Arm Selection, Geometry Limits, etc.). Meritor Axle Engineering can assist the OEM with these parameters selections.
12. Mismatch (which is expressed in terms of a percentage) is the difference in the wheel speed of an all-wheel-drive vehicle's front driving axle and its rear driving axle(s). This difference is affected by the axle ratios as well as the tire size specified on the axles. Mismatch can be calculated using either Tire Static Loaded Radius (SLR) or Tire Revolutions per Mile. The calculation using the SLR is considered the **low speed mismatch** while the results when using the tire REV's is called **high speed mismatch**. For the specific calculation formulas refer to the TRANSFER CASE GUIDELINE.
13. Meritor recommends that the **mismatch** between the front and rear driving axles should not exceed +/- 2.0% for high speed mismatch and +/- 1.5% for low speed mismatch for declutchable transfer cases without a differential, and +/- 3.0% mismatch for units with a differential. If the Transfer Case has neither a declutch or a differential, mismatch must be under +/- 1.0% high or low speed.
14. **Front drive steer axle** should be declutched for On-Highway dry pavement operations. All-wheel-drive is recommended for adverse traction conditions only. Transfer case low gear is recommended when front axle is engaged.
15. **Transfer Case Differential**, if so equipped, must be used for On-Highway operations. Differential lock-out is recommended for adverse traction operations only. Transfer case low gear is recommended for adverse traction conditions and when severe grades are encountered.
16. **Front drive steer axles** are part time axles only, typically used for off-road conditions. When operating the vehicle in all-wheel-drive mode, the Transfer Case should be in low range when available. When Transfer Case is in high range, front axle should be declutched.
17. Drive axles configured with **single tires** may require special consideration. Aggressive High Mobility single tires of on/off-road and agricultural tread designs are capable of transmitting higher than normal wheel torque into the ground surface. This can result in axle components being stressed beyond allowable limits. If single tires are utilized with other than strict On-Highway tread designs, Meritor Axle Engineering should be consulted for special consideration of the application.
18. The **Driver-Controlled Differential Lock** option, when available, is highly recommended for all Fire Service operations where vehicles operate in off road areas.
19. Vehicle testing of any nature voids the warranty on Meritor axles. Meritor does not approve of automatic transmission **stall testing** and does not warrant components against these procedures.

Fire Vocation — Axle Guidelines

Important Notes (Cont'd.)

20. For vehicles using the **TELMA Focal Retarder**, refer to TP-9482 and PIL #221 for TELMA Retarder availability and application limitations. For additional questions contact your Meritor Customer Support representative.
21. For additional **RS-23-186** guidelines, refer to Meritor Product Information Letter (237) or contact Meritor Axle Engineering for clarification.

For more information, dial our
toll-free number: **800-535-5560**

The entire family of Meritor axles is an integral
member of **Drivetrain Plus™** by Meritor, the
industry's most complete drivetrain.



Meritor Heavy Vehicle Systems, LLC
2135 West Maple Road
Troy, MI 48084 U.S.A.
800-535-5560
www.meritorauto.com

Information contained in this publication was in effect at the time the publication was approved for printing and is subject to change without notice or liability. Meritor Heavy Vehicle Systems, LLC, reserves the right to revise the information presented or discontinue the production of parts described at any time.

© Copyright 1998
Meritor Automotive, Inc.
All Rights Reserved

Printed in the USA
Please Recycle

TP-9441FT4
Revised 4-98
16579/Meritor